

TIME RELAY, ELECTRONIC, WITH STAR-DELTA FUNCTION, 1 CONTACTOR DELAYED, 1 CONTACTOR NON-DELAYED, 1 TIME SET. RANGE 1...20S, 12V...240V AC/DC AT AC 50/60HZ, SCREW TERMINAL



Figure similar

General technical data:		
product brandname		SIRIUS
Product designation		timing relay
Design of the product		Star-delta (wye-delta) function
Mounting position		any
Product function at the relay outputs Switchover delayed/without delay		No
Product function non-volatile		No
Product component		
• Relay output		Yes
• semi-conductor output		No
Installation altitude at height above sea level maximum	m	2 000
Ambient temperature		
• during operation	°C	-25 ... +60
• during storage	°C	-40 ... +85
• during transport	°C	-40 ... +85
Relative humidity during operation	%	10 ... 95

EMC emitted interference acc. to IEC 61812-1		EN 61000-6-4(3)
EMI immunity acc. to IEC 61812-1		EN 61000-6-2
Conducted interference due to burst acc. to IEC 61000-4-4		2 kV network connection / 1 kV control connection
Conducted interference due to conductor-earth surge acc. to IEC 61000-4-5		2 kV
Conducted interference due to conductor-conductor surge acc. to IEC 61000-4-5		1 kV
Electrostatic discharge acc. to IEC 61000-4-2		4 kV contact discharge / 8 kV air discharge
Field-bound parasitic coupling acc. to IEC 61000-4-3		10 V/m
Surge voltage resistance rated value	V	4 000
Power loss [W] total typical	W	2
Equipment marking		
<ul style="list-style-type: none"> <li>• acc. to DIN 40719 extended according to IEC 204-2 acc. to IEC 750</li> <li>• acc. to DIN EN 61346-2</li> <li>• acc. to DIN EN 81346-2</li> </ul>		K K K
Category acc. to EN 954-1		none
Protection against electrical shock		finger-safe
Protection class IP		IP20
Type of insulation		Basic insulation
Mechanical service life (switching cycles) typical		10 000 000
Electrical endurance (switching cycles) at AC-15 at 230 V typical		100 000
Operating frequency with 3RT2 contactor maximum	1/h	5 000
Vibration resistance acc. to IEC 60068-2-6		10 ... 55 Hz / 0.35 mm
Shock resistance acc. to IEC 60068-2-27		11g / 15 ms
Relative repeat accuracy	%	1
Recovery time	ms	250
Degree of pollution		3
Insulation voltage for overvoltage category III according to IEC 60664 with degree of pollution 3 rated value	V	300
Relative setting accuracy relating to full-scale value	%	5
Product extension required remote control		No
Product extension optional remote control		No

#### Switching Function:

##### Switching function

<ul style="list-style-type: none"> <li>• ON-delay</li> <li>• ON-delay/instantaneous contact</li> <li>• passing make contact</li> <li>• passing make contact/instantaneous contact</li> <li>• OFF delay</li> <li>• flashing asymmetrically starting with interval</li> </ul>		No No No No No No
---	--	----------------------------------

<ul style="list-style-type: none"> <li>• flashing asymmetrically starting with pulse</li> </ul>	No
<ul style="list-style-type: none"> <li>• flashing symmetrically starting with pulse</li> </ul>	No
<ul style="list-style-type: none"> <li>• flashing symmetrically starting with pulse/instantaneous</li> </ul>	No
<ul style="list-style-type: none"> <li>• flashing symmetrically starting with interval</li> </ul>	No
<ul style="list-style-type: none"> <li>• flashing symmetrically starting with interval/instantaneous</li> </ul>	No
<ul style="list-style-type: none"> <li>• star-delta circuit</li> </ul>	Yes
<ul style="list-style-type: none"> <li>• star-delta circuit with delay time</li> </ul>	No
<b>Switching function with control signal</b>	
<ul style="list-style-type: none"> <li>• additive ON delay</li> </ul>	No
<ul style="list-style-type: none"> <li>• passing break contact</li> </ul>	No
<ul style="list-style-type: none"> <li>• OFF delay</li> </ul>	No
<ul style="list-style-type: none"> <li>• pulse-shaping</li> </ul>	No
<ul style="list-style-type: none"> <li>• OFF delay/instantaneous</li> </ul>	No
<ul style="list-style-type: none"> <li>• ON-delay/OFF-delay/instantaneous</li> </ul>	No
<ul style="list-style-type: none"> <li>• passing break contact/instantaneous</li> </ul>	No
<ul style="list-style-type: none"> <li>• additive ON delay/instantaneous</li> </ul>	No
<ul style="list-style-type: none"> <li>• ON-delay/OFF-delay</li> </ul>	No
<ul style="list-style-type: none"> <li>• passing make contact</li> </ul>	No
<ul style="list-style-type: none"> <li>• passing make contact/instantaneous contact</li> </ul>	No
<ul style="list-style-type: none"> <li>• pulse delayed</li> </ul>	No
<ul style="list-style-type: none"> <li>• pulse delayed/instantaneous</li> </ul>	No
<ul style="list-style-type: none"> <li>• pulse-shaping/instantaneous</li> </ul>	No
<b>Switching function of interval relay with control signal</b>	
<ul style="list-style-type: none"> <li>• retrotriggerable with deactivated control signal/instantaneous contact</li> </ul>	No
<ul style="list-style-type: none"> <li>• retrotriggerable with activated control signal</li> </ul>	No
<ul style="list-style-type: none"> <li>• retrotriggerable with activated control signal/instantaneous contact</li> </ul>	No
<ul style="list-style-type: none"> <li>• retriggerable with deactivated control signal</li> </ul>	No

Control circuit/ Control:		
<b>Adjustable time</b>	s	1 ... 20
<b>Type of voltage of the control supply voltage</b>		AC/DC
<b>Control supply voltage frequency 1</b>	Hz	50 ... 60
<b>Control supply voltage 1</b>		
<ul style="list-style-type: none"> <li>• at AC at 50 Hz</li> </ul>	V	12 ... 240
<ul style="list-style-type: none"> <li>• at AC at 60 Hz</li> </ul>	V	12 ... 240
<ul style="list-style-type: none"> <li>• at DC</li> </ul>	V	12 ... 240
<b>Operating range factor control supply voltage rated value</b>		
<ul style="list-style-type: none"> <li>• at AC</li> </ul>		

— at 50 Hz		0.85 ... 1.1
— at 60 Hz		0.85 ... 1.1
• at DC		0.85 ... 1.1
<b>Inrush current peak</b>		
• at 24 V	A	0.5
• at 240 V	A	5
<b>Duration of inrush current peak</b>		
• at 24 V	ms	0.4
• at 240 V	ms	0.5
<b>Power loss [W] at AC maximum</b>	W	1.1
<b>Power loss [V·A] at AC maximum</b>	V·A	3.3

#### Auxiliary circuit:

<b>Contact reliability of auxiliary contacts</b>		one incorrect switching operation of 100 million switching operations (17 V, 5 mA)
<b>Material of switching contacts</b>		AgSnO2
<b>Operating current of auxiliary contacts</b>		
• at AC-15		
— at 24 V	A	3
— at 250 V	A	3
• at DC-13		
— at 24 V	A	1
— at 125 V	A	0.2
— at 250 V	A	0.1
<b>Influence of the surrounding temperature</b>		1% in the whole temperature range to the set runtime
<b>Power supply influence</b>		1% in the whole voltage range to the set runtime
<b>Test voltage for isolation test</b>	kV	2.5
<b>Design of the fuse link for short-circuit protection of the auxiliary switch required</b>		fuse gL/gG: 4 A
<b>Thermal current</b>	A	5
<b>Switching capacity current with inductive load</b>	A	0.01 ... 3
<b>Number of NC contacts</b>		
• delayed switching		0
• instantaneous contact		0
<b>Number of NO contacts</b>		
• delayed switching		1
• instantaneous contact		1
<b>Number of CO contacts</b>		
• delayed switching		0
• instantaneous contact		0
<b>Contact rating of auxiliary contacts according to UL</b>		R300 / B300

#### Installation/ mounting/ dimensions:





<b>Mounting type</b>		screw and snap-on mounting onto 35 mm standard mounting rail
<b>Width</b>	mm	22.5
<b>Height</b>	mm	100
<b>Depth</b>	mm	90
<b>Required spacing with side-by-side mounting</b>		
• upwards	mm	0
• forwards	mm	0
• at the side	mm	0
• Backwards	mm	0
• downwards	mm	0
<b>Required spacing for grounded parts</b>		
• Backwards	mm	0
• at the side	mm	0
• upwards	mm	0
• forwards	mm	0
• downwards	mm	0
<b>Required spacing for live parts</b>		
• downwards	mm	0
• Backwards	mm	0
• at the side	mm	0
• forwards	mm	0
• upwards	mm	0

**Connections/ Terminals:**

<b>Type of electrical connection for auxiliary and control current circuit</b>		screw-type terminals
<b>Product function removable terminal for auxiliary and control circuit</b>		Yes
<b>Type of connectable conductor cross-sections</b>		
• solid		1x (0.5 ... 4.0 mm <sup>2</sup> ), 2x (0.5 ... 2.5 mm <sup>2</sup> )
• finely stranded — with core end processing		1x (0.5 ... 4 mm <sup>2</sup> ), 2x (0.5 ... 1.5 mm <sup>2</sup> )
• at AWG conductors — stranded		1x (20 ... 12), 2x (20 ... 14)
— solid		1x (20 ... 12), 2x (20 ... 14)
<b>Tightening torque</b>	N·m	0.6 ... 0.8
<b>Design of the thread of the connection screw</b>		M3
<b>Ampacity of the bridge terminals maximum</b>	A	10

**Certificates/approvals**

General Product Approval				Declaration of Conformity	Test Certificates
 CCC	 CSA	 UL		 EG-Konf.	<a href="#">Type Test Certificates/Test Report</a>

Shipping Approval				other	
 LRS	 PRS	 RINA	 RMRS	<a href="#">Environmental Confirmations</a>	<a href="#">Confirmation</a>

### Further information

**Information- and Downloadcenter (Catalogs, Brochures,...)**

<http://www.siemens.com/industrial-controls/catalogs>

**Industry Mall (Online ordering system)**

<https://mall.industry.siemens.com/mall/en/en/Catalog/product?mlfb=3RP2574-1NW30>

**Cax online generator**

<http://support.automation.siemens.com/WW/CAXorder/default.aspx?lang=en&mlfb=3RP2574-1NW30>

**Service&Support (Manuals, Certificates, Characteristics, FAQs,...)**

<https://support.industry.siemens.com/cs/ww/en/ps/3RP2574-1NW30>

**Image database (product images, 2D dimension drawings, 3D models, device circuit diagrams, EPLAN macros, ...)**

[http://www.automation.siemens.com/bilddb/cax\\_de.aspx?mlfb=3RP2574-1NW30&lang=en](http://www.automation.siemens.com/bilddb/cax_de.aspx?mlfb=3RP2574-1NW30&lang=en)

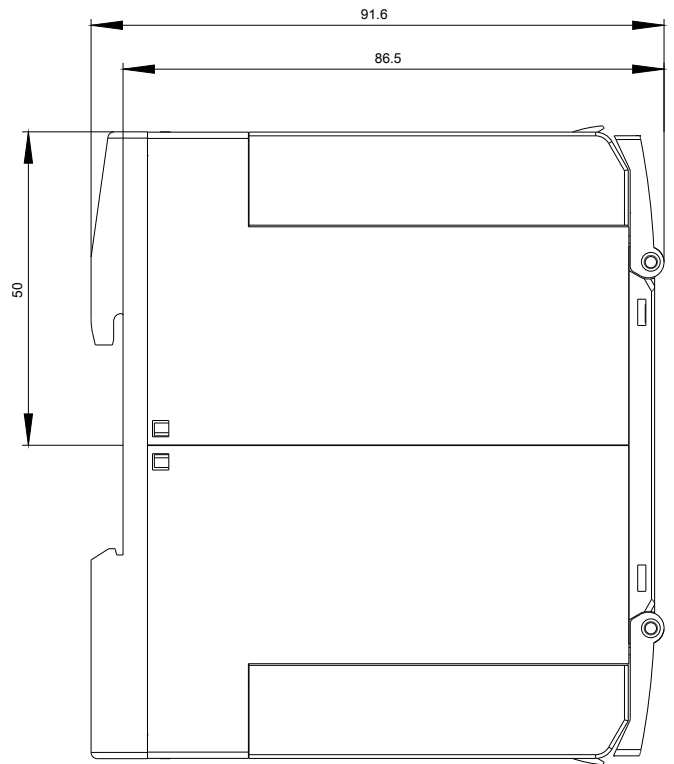
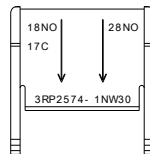
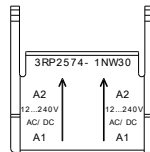
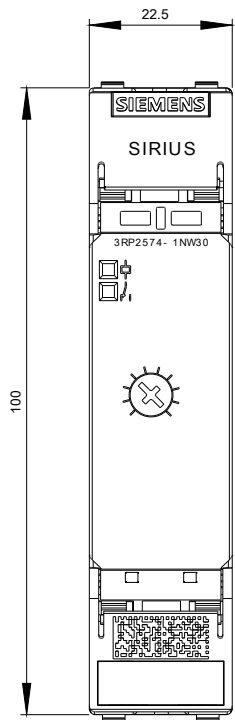

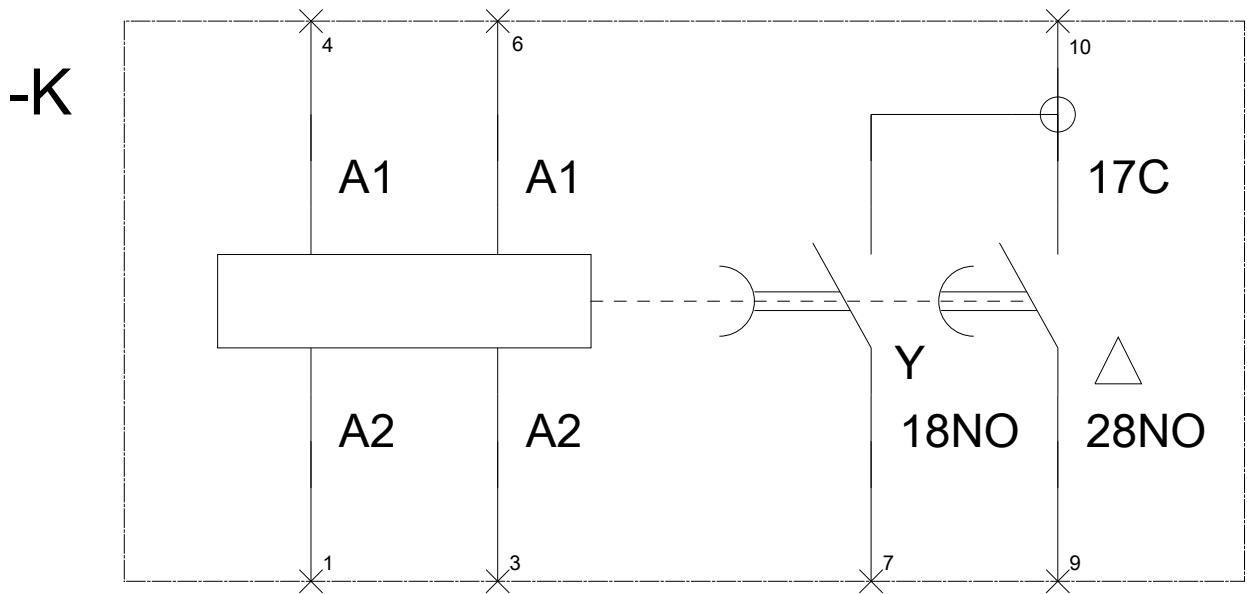

last modified:

06/05/2017