

CONTACTOR, AC-3, 3KW/400V, 1NC, AC110V, 50/60 HZ, 3-POLE,
SZ S00 SCREW TERMINAL



product brandname	SIRIUS
Product designation	Power contactor
Product type designation	3RT2
General technical data	
Size of contactor	S00
Product extension	
• function module for communication	No
• Auxiliary switch	Yes
Insulation voltage	
• rated value	690 V
Surge voltage resistance rated value	6 kV
maximum permissible voltage for safe isolation	
• between coil and main contacts acc. to EN 60947-1	400 V
Protection class IP	
• on the front	IP20
• of the terminal	IP20
Shock resistance at rectangular impulse	
• at AC	6,7g / 5 ms, 4,2g / 10 ms

Shock resistance with sine pulse	
<ul style="list-style-type: none"> • at AC 	10,5g / 5 ms, 6,6g / 10 ms
Mechanical service life (switching cycles)	
<ul style="list-style-type: none"> • of contactor typical 	30 000 000
<ul style="list-style-type: none"> • of the contactor with added electronics-compatible auxiliary switch block typical 	5 000 000
<ul style="list-style-type: none"> • of the contactor with added auxiliary switch block typical 	10 000 000

Ambient conditions

Ambient temperature	
<ul style="list-style-type: none"> • during operation 	-25 ... +60 °C
<ul style="list-style-type: none"> • during storage 	-55 ... +80 °C

Main circuit

Number of poles for main current circuit	3
Number of NO contacts for main contacts	3
Operating voltage	
<ul style="list-style-type: none"> • at AC-3 rated value maximum 	690 V
Operating current	
<ul style="list-style-type: none"> • at AC-1 at 400 V <ul style="list-style-type: none"> — at ambient temperature 40 °C rated value 	18 A
<ul style="list-style-type: none"> • at AC-1 <ul style="list-style-type: none"> — up to 690 V at ambient temperature 40 °C rated value 	18 A
<ul style="list-style-type: none"> — up to 690 V at ambient temperature 60 °C rated value 	16 A
<ul style="list-style-type: none"> • at AC-2 at 400 V rated value 	7 A
<ul style="list-style-type: none"> • at AC-3 <ul style="list-style-type: none"> — at 400 V rated value 	7 A
<ul style="list-style-type: none"> — at 500 V rated value 	6 A
<ul style="list-style-type: none"> — at 690 V rated value 	4.9 A
Connectable conductor cross-section in main circuit at AC-1	
<ul style="list-style-type: none"> • at 60 °C minimum permissible 	2.5 mm ²
<ul style="list-style-type: none"> • at 40 °C minimum permissible 	2.5 mm ²
Operating current for approx. 200000 operating cycles at AC-4	
<ul style="list-style-type: none"> • at 400 V rated value 	2.6 A
<ul style="list-style-type: none"> • at 690 V rated value 	1.8 A
Operating current	
<ul style="list-style-type: none"> • at 1 current path at DC-1 <ul style="list-style-type: none"> — at 24 V rated value 	15 A
<ul style="list-style-type: none"> — at 110 V rated value 	1.5 A

— at 220 V rated value	0.6 A
— at 440 V rated value	0.42 A
— at 600 V rated value	0.42 A
• with 2 current paths in series at DC-1	
— at 24 V rated value	15 A
— at 110 V rated value	8.4 A
— at 220 V rated value	1.2 A
— at 440 V rated value	0.6 A
— at 600 V rated value	0.5 A
• with 3 current paths in series at DC-1	
— at 24 V rated value	15 A
— at 110 V rated value	15 A
— at 220 V rated value	15 A
— at 440 V rated value	0.9 A
— at 600 V rated value	0.7 A
Operating current	
• at 1 current path at DC-3 at DC-5	
— at 24 V rated value	15 A
— at 110 V rated value	0.1 A
• with 2 current paths in series at DC-3 at DC-5	
— at 24 V rated value	15 A
— at 110 V rated value	0.25 A
• with 3 current paths in series at DC-3 at DC-5	
— at 24 V rated value	15 A
— at 110 V rated value	15 A
— at 220 V rated value	1.2 A
— at 440 V rated value	0.14 A
— at 600 V rated value	0.14 A
Operating power	
• at AC-1	
— at 230 V rated value	6.3 kW
— at 230 V at 60 °C rated value	6 kW
— at 400 V rated value	11 kW
— at 400 V at 60 °C rated value	10.5 kW
— at 690 V rated value	19 kW
— at 690 V at 60 °C rated value	18 kW
• at AC-2 at 400 V rated value	3 kW
• at AC-3	
— at 230 V rated value	1.5 kW
— at 400 V rated value	3 kW
— at 690 V rated value	4 kW

Operating power for approx. 200000 operating cycles at AC-4	
<ul style="list-style-type: none"> • at 400 V rated value • at 690 V rated value 	1.15 kW 1.15 kW
Thermal short-time current limited to 10 s	56 A
Power loss [W] at AC-3 at 400 V for rated value of the operating current per conductor	0.4 W
No-load switching frequency	
<ul style="list-style-type: none"> • at AC 	10 000 1/h
Operating frequency	
<ul style="list-style-type: none"> • at AC-1 maximum • at AC-2 maximum • at AC-3 maximum • at AC-4 maximum 	1 000 1/h 750 1/h 750 1/h 250 1/h

Control circuit/ Control	
Type of voltage of the control supply voltage	AC
Control supply voltage at AC	
<ul style="list-style-type: none"> • at 50 Hz rated value • at 60 Hz rated value 	110 V 110 V
Operating range factor control supply voltage rated value of magnet coil at AC	
<ul style="list-style-type: none"> • at 50 Hz • at 60 Hz 	0.8 ... 1.1 0.85 ... 1.1
Apparent pick-up power of magnet coil at AC	
<ul style="list-style-type: none"> • at 50 Hz • at 60 Hz 	27 V·A 31.7 V·A
Inductive power factor with closing power of the coil	
<ul style="list-style-type: none"> • at 50 Hz • at 60 Hz 	0.8 0.81
Apparent holding power of magnet coil at AC	
<ul style="list-style-type: none"> • at 50 Hz • at 60 Hz 	4.2 V·A 4.8 V·A
Inductive power factor with the holding power of the coil	
<ul style="list-style-type: none"> • at 50 Hz • at 60 Hz 	0.25 0.25
Closing delay	
<ul style="list-style-type: none"> • at AC 	9 ... 35 ms
Opening delay	
<ul style="list-style-type: none"> • at AC 	3.5 ... 14 ms
Arcing time	10 ... 15 ms
Residual current of the electronics for control with signal <0>	

- at AC at 230 V maximum permissible 3 mA
- at DC at 24 V maximum permissible 10 mA

Auxiliary circuit

Number of NC contacts	
<ul style="list-style-type: none"> • for auxiliary contacts <ul style="list-style-type: none"> — instantaneous contact 1 	
Operating current at AC-12 maximum	10 A
Operating current at AC-15	
<ul style="list-style-type: none"> • at 230 V rated value 10 A • at 400 V rated value 3 A • at 500 V rated value 2 A • at 690 V rated value 1 A 	
Operating current at DC-12	
<ul style="list-style-type: none"> • at 24 V rated value 10 A • at 48 V rated value 6 A • at 60 V rated value 6 A • at 110 V rated value 3 A • at 125 V rated value 2 A • at 220 V rated value 1 A • at 600 V rated value 0.15 A 	
Operating current at DC-13	
<ul style="list-style-type: none"> • at 24 V rated value 10 A • at 48 V rated value 2 A • at 60 V rated value 2 A • at 110 V rated value 1 A • at 125 V rated value 0.9 A • at 220 V rated value 0.3 A • at 600 V rated value 0.1 A 	
Contact reliability of auxiliary contacts	1 faulty switching per 100 million (17 V, 1 mA)





UL/CSA ratings

Full-load current (FLA) for three-phase AC motor	
<ul style="list-style-type: none"> • at 480 V rated value 4.8 A • at 600 V rated value 6.1 A 	
Yielded mechanical performance [hp]	
<ul style="list-style-type: none"> • for single-phase AC motor <ul style="list-style-type: none"> — at 110/120 V rated value 0.25 hp — at 230 V rated value 0.75 hp • for three-phase AC motor <ul style="list-style-type: none"> — at 200/208 V rated value 1.5 hp — at 220/230 V rated value 2 hp — at 460/480 V rated value 3 hp 	





— at 575/600 V rated value	5 hp
Contact rating of auxiliary contacts according to UL	A600 / Q600
Short-circuit protection	
Design of the fuse link <ul style="list-style-type: none"> • for short-circuit protection of the main circuit <ul style="list-style-type: none"> — with type of coordination 1 required — with type of assignment 2 required • for short-circuit protection of the auxiliary switch required 	gG NH 3NA, DIAZED 5SB, NEOZED 5SE: 35 A gG NH 3NA, DIAZED 5SB, NEOZED 5SE: 20 A fuse gG: 10 A
Installation/ mounting/ dimensions	
Mounting position	+/-180° rotation possible on vertical mounting surface; can be tilted forward and backward by +/- 22.5° on vertical mounting surface
Mounting type <ul style="list-style-type: none"> • Side-by-side mounting 	screw and snap-on mounting onto 35 mm standard mounting rail according to DIN EN 60715 Yes
Height	58 mm
Width	45 mm
Depth	73 mm
Required spacing <ul style="list-style-type: none"> • for grounded parts <ul style="list-style-type: none"> — at the side • for live parts <ul style="list-style-type: none"> — at the side 	6 mm 6 mm
Connections/Terminals	
Type of electrical connection <ul style="list-style-type: none"> • for main current circuit • for auxiliary and control current circuit 	screw-type terminals screw-type terminals
Type of connectable conductor cross-sections <ul style="list-style-type: none"> • for main contacts <ul style="list-style-type: none"> — solid — single or multi-stranded — finely stranded with core end processing • at AWG conductors for main contacts 	2x (0.5 ... 1.5 mm ²), 2x (0.75 ... 2.5 mm ²), 2x 4 mm ² 2x (0,5 ... 1,5 mm ²), 2x (0,75 ... 2,5 mm ²), 2x 4 mm ² 2x (0.5 ... 1.5 mm ²), 2x (0.75 ... 2.5 mm ²) 2x (20 ... 16), 2x (18 ... 14), 2x 12
Type of connectable conductor cross-sections <ul style="list-style-type: none"> • for auxiliary contacts <ul style="list-style-type: none"> — single or multi-stranded — finely stranded with core end processing • at AWG conductors for auxiliary contacts 	2x (0,5 ... 1,5 mm ²), 2x (0,75 ... 2,5 mm ²), 2x 4 mm ² 2x (0.5 ... 1.5 mm ²), 2x (0.75 ... 2.5 mm ²) 2x (20 ... 16), 2x (18 ... 14), 2x 12
Safety related data	
B10 value	

• with high demand rate acc. to SN 31920	1 000 000
Proportion of dangerous failures	
• with low demand rate acc. to SN 31920	40 %
• with high demand rate acc. to SN 31920	73 %
Failure rate [FIT]	
• with low demand rate acc. to SN 31920	100 FIT
Product function	
• Mirror contact acc. to IEC 60947-4-1	Yes
T1 value for proof test interval or service life acc. to IEC 61508	20 y
Protection against electrical shock	finger-safe

Certificates/approvals

General Product Approval	Functional Safety/Safety of Machinery
 CCC	 CSA
 UL	KTL
 EAC	Baumusterbescheinigung

Declaration of Conformity	Test Certificates	Shipping Approval
 EG-Konf.	spezielle Prüfbescheinigungen n	 ABS
	Typprüfbescheinigung/Werkszeugnis	 BUREAU VERITAS
		 GL

Shipping Approval	other
 LRS	 PRS
 RINA	 RMRS
	Umweltbestätigung
	Bestätigungen

other
 VDE

Further information

Information- and Downloadcenter (Catalogs, Brochures,...)
<http://www.siemens.com/industrial-controls/catalogs>

Industry Mall (Online ordering system)

<https://mall.industry.siemens.com/mall/en/en/Catalog/product?mlfb=3RT2015-1AF02>

Cax online generator

<http://support.automation.siemens.com/WW/CAXorder/default.aspx?lang=en&mlfb=3RT2015-1AF02>

Service&Support (Manuals, Certificates, Characteristics, FAQs,...)

<https://support.industry.siemens.com/cs/ww/en/ps/3RT2015-1AF02>

Image database (product images, 2D dimension drawings, 3D models, device circuit diagrams, EPLAN macros, ...)

http://www.automation.siemens.com/bilddb/cax_de.aspx?mlfb=3RT2015-1AF02&lang=en

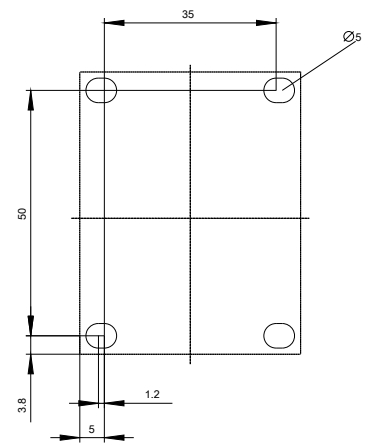
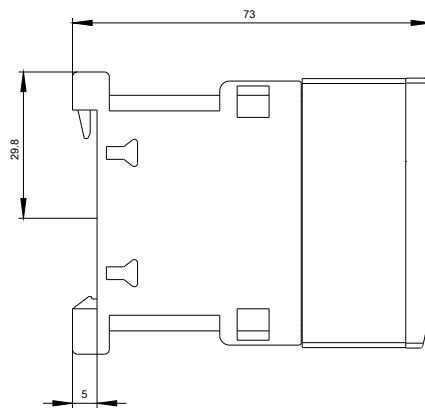
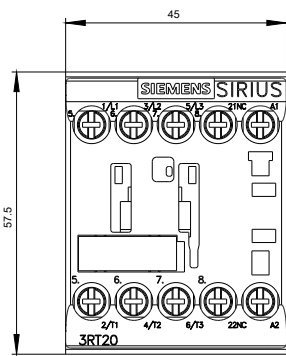

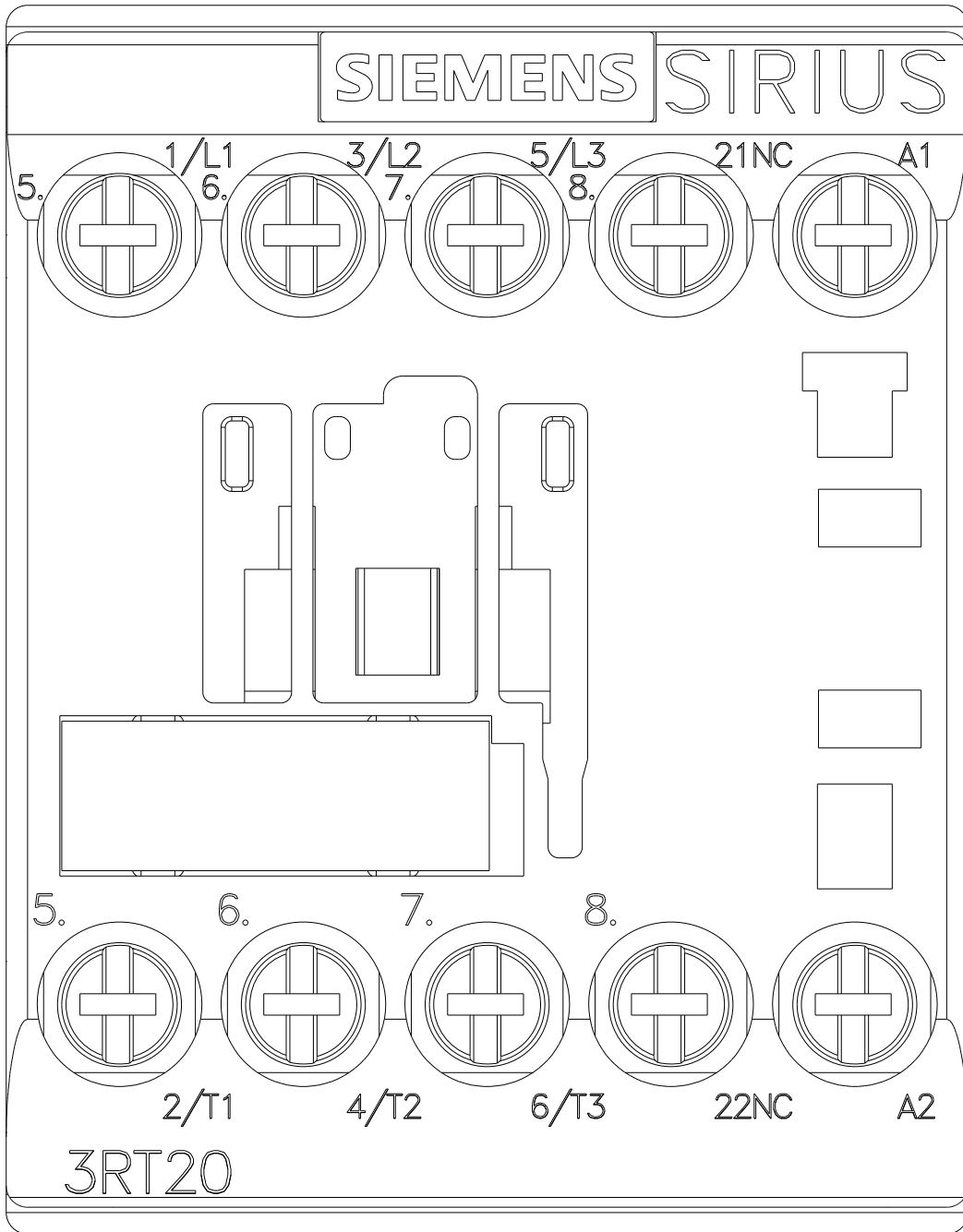

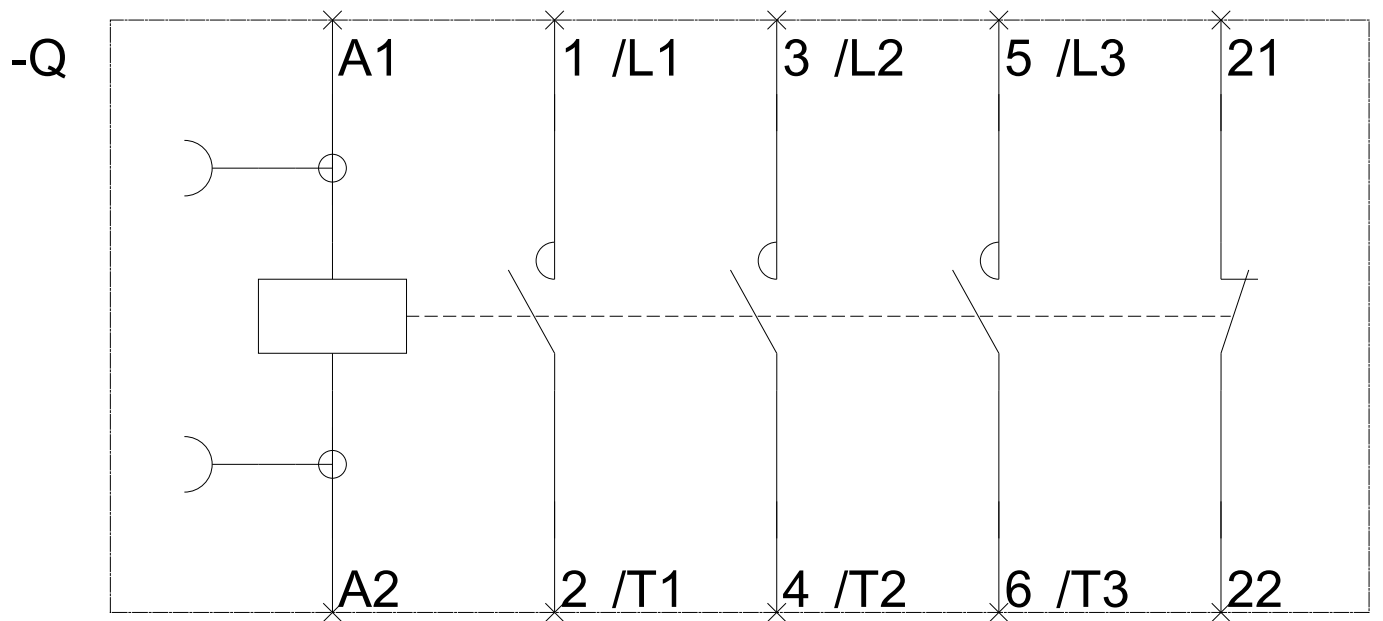

last modified:

05/15/2017