

MOTOR STARTER SIRIUS 3RM1 REVERSING STARTER 500 V;
1,6-7,0 A; 24 V DC SCREW-TYPE CONNECTION SYSTEM



Figure similar

General technical data:	
product brand name	SIRIUS
Product designation	Motor starter
Design of the product	with reversing functionality and electronic overload protection
Trip class	CLASS 10A
Protection class IP	IP20
Suitability for operation Device connector 3ZY12	Yes
Product function Intrinsic device protection	Yes
Type of the motor protection	solid-state
Product function Adjustable current limitation	Yes
Installation altitude at height above sea level maximum	4 000 m
Ambient temperature	
• during operation	-25 ... +60 °C
• during transport	-40 ... +70 °C
• during storage	-40 ... +70 °C
Relative humidity during operation	10 ... 95 %
Air pressure acc. to SN 31205	900 ... 1 060 hPa
Shock resistance	6g / 11 ms

Vibration resistance	1 ... 6 Hz, 15 mm; 20 m/s ² , 500 Hz
Surge voltage resistance rated value	6 kV
Insulation voltage rated value	500 V
Mechanical service life (switching cycles) typical	30 000 000
Conducted interference	
<ul style="list-style-type: none"> • due to conductor-conductor surge acc. to IEC 61000-4-5 	1 kV
<ul style="list-style-type: none"> • due to conductor-earth surge acc. to IEC 61000-4-5 	2 kV
<ul style="list-style-type: none"> • due to burst acc. to IEC 61000-4-4 	3 kV / 5 kHz
<ul style="list-style-type: none"> • due to high-frequency radiation acc. to IEC 61000-4-6 	10 V
Electrostatic discharge acc. to IEC 61000-4-2	4 kV contact discharge / 8 kV air discharge
Field-bound HF-interference emission acc. to CISPR11	Class B for the domestic, business and commercial environments
Conducted HF-interference emissions acc. to CISPR11	Class B for the domestic, business and commercial environments
maximum permissible voltage for safe isolation	
<ul style="list-style-type: none"> • between main and auxiliary circuit 	500 V
<ul style="list-style-type: none"> • between control and auxiliary circuit 	250 V
Equipment marking acc. to DIN 40719 extended according to IEC 204-2 acc. to IEC 750	Q
Equipment marking acc. to DIN EN 61346-2	Q

Safety related data:

Protection against electrical shock	finger-safe
-------------------------------------	-------------

Main circuit:







Number of poles for main current circuit	3
Operating voltage rated value maximum	500 V
Relative symmetrical tolerance of the operating voltage	10 %
Operating frequency	
<ul style="list-style-type: none"> • 1 rated value 	50 Hz
<ul style="list-style-type: none"> • 2 rated value 	60 Hz
Relative symmetrical tolerance of the operating frequency	10 %
Operating current at AC-53a at 400 V at ambient temperature 40 °C rated value	7 A
Derating temperature	40 °C
Minimum load [% of IM]	20 %
Power loss [W] typical	3.4 W
Adjustable pick-up value current of the current-dependent overload release	1.6 ... 7 A
Operating power for three-phase motors at 400 V at 50 Hz	0.55 ... 3 kW

Operating frequency maximum	1 1/s
Control circuit/ Control:	
Type of voltage of the control supply voltage	DC
Control supply voltage 1	24 V
<ul style="list-style-type: none"> • at DC rated value 	
Operating range factor control supply voltage rated value	0.8 ... 1.25
<ul style="list-style-type: none"> • at DC 	
Control current	
<ul style="list-style-type: none"> • at DC <ul style="list-style-type: none"> — in standby mode — during operation — when switching on 	25 mA 70 mA 150 mA
Input voltage at digital input	
<ul style="list-style-type: none"> • for signal <1> <ul style="list-style-type: none"> — at DC • with signal <0> <ul style="list-style-type: none"> — at DC 	15 ... 30 V 0 ... 5 V
Input current at digital input	
<ul style="list-style-type: none"> • for signal <1> <ul style="list-style-type: none"> — at DC • with signal <0> <ul style="list-style-type: none"> — at DC 	11 mA 1 mA
Switch-on delay time	60 ... 90 ms
Off-delay time	60 ... 90 ms
Auxiliary circuit:	
Number of CO contacts for auxiliary contacts	1
Operating current of auxiliary contacts	
<ul style="list-style-type: none"> • at AC-15 at 230 V maximum • at DC-13 at 24 V maximum 	3 A 1 A
Installation/ mounting/ dimensions:	
Mounting position	vertical, horizontal, standing
Mounting type	screw and snap-on mounting onto 35 mm standard mounting rail
Width	22.5 mm
Height	100 mm
Depth	141.6 mm
Connections/ Terminals:	
Type of electrical connection	
<ul style="list-style-type: none"> • for main current circuit • for auxiliary and control current circuit 	screw-type terminals screw-type terminals

Type of connectable conductor cross-sections for main contacts	
<ul style="list-style-type: none"> • solid • finely stranded <ul style="list-style-type: none"> — with core end processing 	<p>1x (0,5 ... 4 mm²), 2x (0,5 ... 2,5 mm²)</p> <p>1x (0,5 ... 2,5 mm²), 2x (0,5 ... 1,5 mm²)</p>
Type of connectable conductor cross-sections at AWG conductors for main contacts	1x (20 ... 12), 2x (20 ... 14)
Type of connectable conductor cross-sections for auxiliary contacts	
<ul style="list-style-type: none"> • solid • finely stranded <ul style="list-style-type: none"> — with core end processing 	<p>1x (0,5 ... 2,5 mm²), 2x (1,0 ... 1,5 mm²)</p> <p>1x (0,5 ... 2,5 mm²), 2x (0,5 ... 1 mm²)</p>
Type of connectable conductor cross-sections at AWG conductors for auxiliary contacts	1x (20 ... 14), 2x (18 ... 16)

UL ratings:	
Full-load current (FLA) for three-phase AC motor at 480 V rated value	6.1 A
Yielded mechanical performance [hp]	
<ul style="list-style-type: none"> • for single-phase AC motor <ul style="list-style-type: none"> — at 110/120 V rated value — at 230 V rated value • for three-phase AC motor <ul style="list-style-type: none"> — at 200/208 V rated value — at 220/230 V rated value — at 460/480 V rated value 	<p>0.25 hp</p> <p>0.5 hp</p> <p>1 hp</p> <p>1.5 hp</p> <p>3 hp</p>

Certificates/approvals

General Product Approval	Declaration of Conformity
 CCC	 CSA
 GOST	 UL
 EAC	 EG-Konf.

Test Certificates	other
Typprüfbescheinigung/Werkszeugnis	spezielle Prüfbescheinigungen
	Umweltbestätigung
	Bestätigungen

Further information

Information- and Downloadcenter (Catalogs, Brochures,...)
<http://www.siemens.com/industrial-controls/catalogs>

Industry Mall (Online ordering system)

<https://mall.industry.siemens.com/mall/en/en/Catalog/product?mlfb=3RM12071AA04>

Cax online generator

<http://support.automation.siemens.com/WW/CAXorder/default.aspx?lang=en&mlfb=3RM12071AA04>

Service&Support (Manuals, Certificates, Characteristics, FAQs,...)

<https://support.industry.siemens.com/cs/ww/en/ps/3RM12071AA04>

Image database (product images, 2D dimension drawings, 3D models, device circuit diagrams, EPLAN macros, ...)

http://www.automation.siemens.com/bilddb/cax_de.aspx?mlfb=3RM12071AA04&lang=en

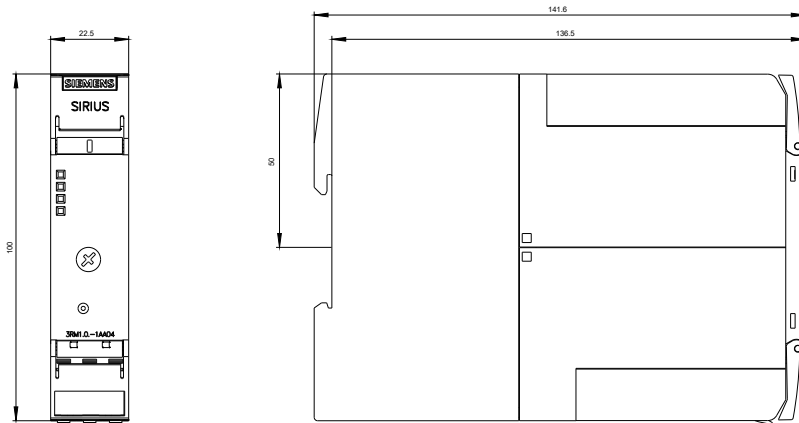

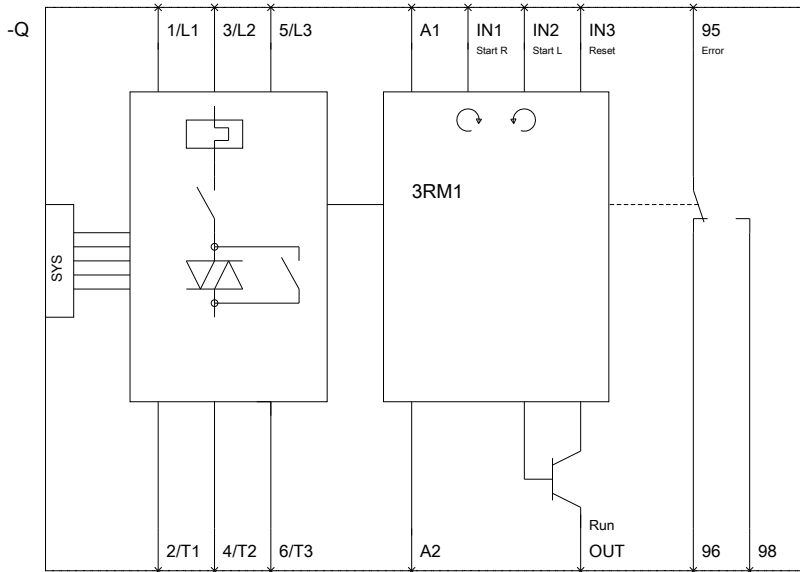

last modified:

14.03.2016