

Support terminal, black, spring-type terminal, for floor mounting



Product brand name	SIRIUS ACT
Product designation	Support terminal
Product type designation	3SU1

### General technical data

Suitability for integration	yes
Degree of pollution	3
Surge voltage resistance rated value	6 kV
Protection class IP	
• of the enclosure	IP40
• of the terminal	IP20
Reference code acc. to DIN EN 81346-2	S
Reference code acc. to DIN EN 61346-2	S

### Connections/ Terminals

Type of electrical connection	spring-loaded terminals
• of modules and accessories	Spring-type terminal

### Ambient conditions

Ambient temperature	
• during operation	-25 ... +70 °C





- during storage

-40 ... +80 °C

### Installation/ mounting/ dimensions





<b>Mounting type</b>	Floor mounting
<ul style="list-style-type: none"> <li>• of modules and accessories</li> </ul>	
<b>Height</b>	36 mm
<b>Width</b>	9.8 mm
<b>Depth</b>	33.6 mm

### Certificates/ approvals

General Product Approval	Declaration of Conformity	Test Certificates	Marine / Shipping
 UL	 EAC	 EG-Konf.	 ABS

[Miscellaneous](#)

[Type Test Certificates/Test Report](#)

Marine / Shipping	other
 LRS  PRS  RINA  RMRS	<a href="#">Confirmation</a>

### Further information

**Information- and Downloadcenter (Catalogs, Brochures,...)**

<https://www.siemens.com/ic10>

**Industry Mall (Online ordering system)**

<https://mall.industry.siemens.com/mall/en/en/Catalog/product?mfb=3SU1400-2DA10-3AA0>

**Cax online generator**

<http://support.automation.siemens.com/WW/CAXorder/default.aspx?lang=en&mfb=3SU1400-2DA10-3AA0>

**Service&Support (Manuals, Certificates, Characteristics, FAQs,...)**

<https://support.industry.siemens.com/cs/ww/en/ps/3SU1400-2DA10-3AA0>

**Image database (product images, 2D dimension drawings, 3D models, device circuit diagrams, EPLAN macros, ...)**

[http://www.automation.siemens.com/bilddb/cax\\_de.aspx?mfb=3SU1400-2DA10-3AA0&lang=en](http://www.automation.siemens.com/bilddb/cax_de.aspx?mfb=3SU1400-2DA10-3AA0&lang=en)

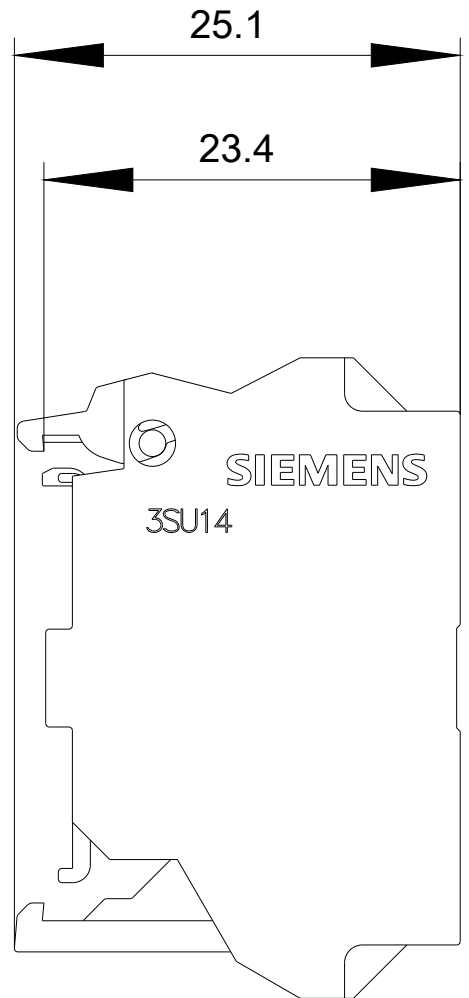
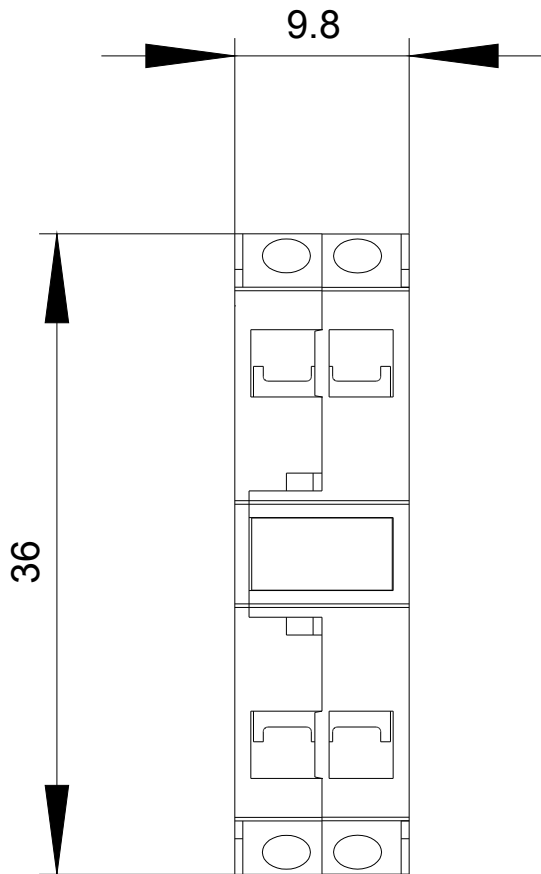

last modified:

06/08/2020