

Power contactor, AC-3 7 A, 3 kW / 400 V 1 NO, 100 V AC, 50 Hz
100-110 V, 60 Hz, 3-pole Size S00, screw terminal



Product brand name	SIRIUS
Product designation	Power contactor
Product type designation	3RT2
General technical data	
Size of contactor	S00
Product extension	
• function module for communication	No
• Auxiliary switch	Yes
Surge voltage resistance	
• of main circuit rated value	6 kV
• of auxiliary circuit rated value	6 kV
maximum permissible voltage for safe isolation	
• between coil and main contacts acc. to EN 60947-1	400 V
Protection class IP	
• on the front	IP20
• of the terminal	IP20
Shock resistance at rectangular impulse	
• at AC	6,7g / 5 ms, 4,2g / 10 ms

Shock resistance with sine pulse	
• at AC	10,5g / 5 ms, 6,6g / 10 ms
Mechanical service life (switching cycles)	
• of contactor typical	30 000 000
• of the contactor with added electronics-compatible auxiliary switch block typical	5 000 000
• of the contactor with added auxiliary switch block typical	10 000 000
Reference code acc. to DIN 40719 extended according to IEC 204-2 acc. to IEC 750	K
Reference code acc. to DIN EN 81346-2	Q

Ambient conditions

Installation altitude at height above sea level	
• maximum	2 000 m
Ambient temperature	
• during operation	-25 ... +60 °C
• during storage	-55 ... +80 °C

Main circuit

Number of poles for main current circuit	3
Number of NO contacts for main contacts	3
Operating voltage	
• at AC-3 rated value maximum	690 V
Operating current	
• at AC-1 at 400 V	
— at ambient temperature 40 °C rated value	18 A
• at AC-1	
— up to 690 V at ambient temperature 40 °C rated value	18 A
— up to 690 V at ambient temperature 60 °C rated value	16 A
• at AC-2 at 400 V rated value	7 A
• at AC-3	
— at 400 V rated value	7 A
— at 500 V rated value	6 A
— at 690 V rated value	4.9 A
• at AC-4 at 400 V rated value	6.5 A
• at AC-5a up to 690 V rated value	15.8 A
• at AC-5b up to 400 V rated value	5.8 A
• at AC-6a	
— up to 230 V for current peak value n=20 rated value	4 A

— up to 400 V for current peak value n=20 rated value	4 A
— up to 500 V for current peak value n=20 rated value	3.8 A
— up to 690 V for current peak value n=20 rated value	3.6 A
• at AC-6a	
— up to 230 V for current peak value n=30 rated value	2.7 A
— up to 400 V for current peak value n=30 rated value	2.7 A
— up to 500 V for current peak value n=30 rated value	2.5 A
— up to 690 V for current peak value n=30 rated value	2.4 A
Minimum cross-section in main circuit	
• at maximum AC-1 rated value	2.5 mm ²
Operating current for approx. 200000 operating cycles at AC-4	
• at 400 V rated value	2.6 A
• at 690 V rated value	1.8 A
Operating current	
• at 1 current path at DC-1	
— at 24 V rated value	15 A
— at 110 V rated value	1.5 A
— at 220 V rated value	0.6 A
— at 440 V rated value	0.42 A
— at 600 V rated value	0.42 A
• with 2 current paths in series at DC-1	
— at 24 V rated value	15 A
— at 110 V rated value	8.4 A
— at 220 V rated value	1.2 A
— at 440 V rated value	0.6 A
— at 600 V rated value	0.5 A
• with 3 current paths in series at DC-1	
— at 24 V rated value	15 A
— at 110 V rated value	15 A
— at 220 V rated value	15 A
— at 440 V rated value	0.9 A
— at 600 V rated value	0.7 A
Operating current	
• at 1 current path at DC-3 at DC-5	
— at 24 V rated value	15 A

<ul style="list-style-type: none"> — at 110 V rated value • with 2 current paths in series at DC-3 at DC-5 <ul style="list-style-type: none"> — at 24 V rated value — at 110 V rated value • with 3 current paths in series at DC-3 at DC-5 <ul style="list-style-type: none"> — at 24 V rated value — at 110 V rated value — at 220 V rated value — at 440 V rated value — at 600 V rated value 	<p>0.1 A</p> <p>15 A</p> <p>0.25 A</p> <p>15 A</p> <p>15 A</p> <p>1.2 A</p> <p>0.14 A</p> <p>0.14 A</p>
Operating power	
<ul style="list-style-type: none"> • at AC-1 <ul style="list-style-type: none"> — at 230 V rated value — at 230 V at 60 °C rated value — at 400 V rated value — at 400 V at 60 °C rated value — at 690 V rated value — at 690 V at 60 °C rated value • at AC-2 at 400 V rated value • at AC-3 <ul style="list-style-type: none"> — at 230 V rated value — at 400 V rated value — at 500 V rated value — at 690 V rated value 	<p>6.3 kW</p> <p>6 kW</p> <p>11 kW</p> <p>10.5 kW</p> <p>19 kW</p> <p>18 kW</p> <p>3 kW</p> <p>1.5 kW</p> <p>3 kW</p> <p>3 kW</p> <p>4 kW</p>
Operating power for approx. 200000 operating cycles at AC-4	
<ul style="list-style-type: none"> • at 400 V rated value • at 690 V rated value 	<p>1.15 kW</p> <p>1.15 kW</p>
Thermal short-time current limited to 10 s	56 A
No-load switching frequency	
<ul style="list-style-type: none"> • at AC 	10 000 1/h
Operating frequency	
<ul style="list-style-type: none"> • at AC-1 maximum • at AC-2 maximum • at AC-3 maximum • at AC-4 maximum 	<p>1 000 1/h</p> <p>750 1/h</p> <p>750 1/h</p> <p>250 1/h</p>
Control circuit/ Control	
Type of voltage of the control supply voltage	AC
Control supply voltage at AC	
<ul style="list-style-type: none"> • at 50 Hz rated value • at 60 Hz rated value 	<p>100 V</p> <p>110 V</p>

Operating range factor control supply voltage rated value of magnet coil at AC	
• at 50 Hz	0.8 ... 1.1
• at 60 Hz	0.85 ... 1.1
Apparent pick-up power of magnet coil at AC	
• at 50 Hz	26.4 V·A
• at 60 Hz	31.7 V·A
Inductive power factor with closing power of the coil	
• at 50 Hz	0.81
• at 60 Hz	0.81
Apparent holding power of magnet coil at AC	
• at 50 Hz	4.4 V·A
• at 60 Hz	4.8 V·A
Inductive power factor with the holding power of the coil	
• at 50 Hz	0.24
• at 60 Hz	0.25
Closing delay	
• at AC	9 ... 35 ms
Opening delay	
• at AC	3.5 ... 14 ms
Arcing time	10 ... 15 ms
Control version of the switch operating mechanism	Standard A1 - A2

Auxiliary circuit

Number of NO contacts for auxiliary contacts	
• instantaneous contact	1
Operating current at AC-12 maximum	10 A
Operating current at AC-15	
• at 230 V rated value	10 A
• at 400 V rated value	3 A
• at 500 V rated value	2 A
• at 690 V rated value	1 A
Operating current at DC-12	
• at 24 V rated value	10 A
• at 48 V rated value	6 A
• at 60 V rated value	6 A
• at 110 V rated value	3 A
• at 125 V rated value	2 A
• at 220 V rated value	1 A
• at 600 V rated value	0.15 A
Operating current at DC-13	
• at 24 V rated value	10 A

<ul style="list-style-type: none"> • at 48 V rated value • at 60 V rated value • at 110 V rated value • at 125 V rated value • at 220 V rated value • at 600 V rated value 	<p>2 A</p> <p>2 A</p> <p>1 A</p> <p>0.9 A</p> <p>0.3 A</p> <p>0.1 A</p>
Contact reliability of auxiliary contacts	1 faulty switching per 100 million (17 V, 1 mA)

UL/CSA ratings

Full-load current (FLA) for three-phase AC motor	
<ul style="list-style-type: none"> • at 480 V rated value • at 600 V rated value 	<p>4.8 A</p> <p>6.1 A</p>
Yielded mechanical performance [hp]	
<ul style="list-style-type: none"> • for single-phase AC motor <ul style="list-style-type: none"> — at 110/120 V rated value — at 230 V rated value • for three-phase AC motor <ul style="list-style-type: none"> — at 200/208 V rated value — at 220/230 V rated value — at 460/480 V rated value — at 575/600 V rated value 	<p>0.25 hp</p> <p>0.75 hp</p> <p>1.5 hp</p> <p>2 hp</p> <p>3 hp</p> <p>5 hp</p>
Contact rating of auxiliary contacts according to UL	A600 / Q600

Short-circuit protection

Design of the fuse link	
<ul style="list-style-type: none"> • for short-circuit protection of the main circuit <ul style="list-style-type: none"> — with type of coordination 1 required — with type of assignment 2 required • for short-circuit protection of the auxiliary switch required 	<p>gG: 35A (690V,100kA), aM: 20A (690V,100kA), BS88: 35A (415V,80kA)</p> <p>gG: 20A (690V,100kA), aM: 16A (690V, 100kA), BS88: 20A (415V, 80kA)</p> <p>gG: 10 A (500 V, 1 kA)</p>

Installation/ mounting/ dimensions

Mounting position	+/-180° rotation possible on vertical mounting surface; can be tilted forward and backward by +/- 22.5° on vertical mounting surface
Mounting type	screw and snap-on mounting onto 35 mm standard mounting rail according to DIN EN 60715
<ul style="list-style-type: none"> • Side-by-side mounting 	Yes
Height	58 mm
Width	45 mm
Depth	73 mm
Required spacing	
<ul style="list-style-type: none"> • with side-by-side mounting 	

— forwards	10 mm
— upwards	10 mm
— downwards	10 mm
— at the side	0 mm
• for grounded parts	
— forwards	10 mm
— upwards	10 mm
— at the side	6 mm
— downwards	10 mm
• for live parts	
— forwards	10 mm
— upwards	10 mm
— downwards	10 mm
— at the side	6 mm

Connections/ Terminals

Type of electrical connection	
• for main current circuit	screw-type terminals
• for auxiliary and control current circuit	screw-type terminals
• at contactor for auxiliary contacts	Screw-type terminals
• of magnet coil	Screw-type terminals
Type of connectable conductor cross-sections	
• for main contacts	
— solid	2x (0.5 ... 1.5 mm ²), 2x (0.75 ... 2.5 mm ²), 2x 4 mm ²
— single or multi-stranded	2x (0,5 ... 1,5 mm ²), 2x (0,75 ... 2,5 mm ²), 2x 4 mm ²
— finely stranded with core end processing	2x (0.5 ... 1.5 mm ²), 2x (0.75 ... 2.5 mm ²)
• at AWG conductors for main contacts	2x (20 ... 16), 2x (18 ... 14), 2x 12
Connectable conductor cross-section for main contacts	
• solid	0.5 ... 4 mm ²
• stranded	0.5 ... 4 mm ²
• finely stranded with core end processing	0.5 ... 2.5 mm ²
Connectable conductor cross-section for auxiliary contacts	
• single or multi-stranded	0.5 ... 4 mm ²
• finely stranded with core end processing	0.5 ... 2.5 mm ²
Type of connectable conductor cross-sections	
• for auxiliary contacts	
— single or multi-stranded	2x (0,5 ... 1,5 mm ²), 2x (0,75 ... 2,5 mm ²), 2x 4 mm ²
— finely stranded with core end processing	2x (0.5 ... 1.5 mm ²), 2x (0.75 ... 2.5 mm ²)
• at AWG conductors for auxiliary contacts	2x (20 ... 16), 2x (18 ... 14), 2x 12
AWG number as coded connectable conductor cross section	

- for main contacts
- for auxiliary contacts





20 ... 12



20 ... 12







Safety related data

B10 value	
<ul style="list-style-type: none"> • with high demand rate acc. to SN 31920 	1 000 000
Proportion of dangerous failures	
<ul style="list-style-type: none"> • with low demand rate acc. to SN 31920 	40 %
<ul style="list-style-type: none"> • with high demand rate acc. to SN 31920 	73 %
Failure rate [FIT]	
<ul style="list-style-type: none"> • with low demand rate acc. to SN 31920 	100 FIT
Product function	
<ul style="list-style-type: none"> • Mirror contact acc. to IEC 60947-4-1 	Yes; with 3RH29
T1 value for proof test interval or service life acc. to IEC 61508	20 y
Protection against electrical shock	finger-safe

Certificates/ approvals

General Product Approval				EMC
			KC	
CCC	CSA	UL		
				RCM

Functional Safety/Safety of Machinery	Declaration of Conformity	Test Certificates	Marine / Shipping
Type Examination Certificate		Miscellaneous	
	EG-Konf.	Type Test Certificates/Test Report	ABS
		Special Test Certificate	

Marine / Shipping					
					
BUREAU VERITAS	LRS	PRS	RINA	RMRS	TYPE APPROVED PRODUCT DNV-GL DNVGL.COM/AF

other
Confirmation

VDE

Further information

Information- and Downloadcenter (Catalogs, Brochures,...)

www.siemens.com/sirius/catalogs

Industry Mall (Online ordering system)

<https://mall.industry.siemens.com/mall/en/en/Catalog/product?mlfb=3RT2015-1AG61>

Cax online generator

<http://support.automation.siemens.com/WW/CAXorder/default.aspx?lang=en&mlfb=3RT2015-1AG61>

Service&Support (Manuals, Certificates, Characteristics, FAQs,...)

<https://support.industry.siemens.com/cs/ww/en/ps/3RT2015-1AG61>

Image database (product images, 2D dimension drawings, 3D models, device circuit diagrams, EPLAN macros, ...)

http://www.automation.siemens.com/bilddb/cax_de.aspx?mlfb=3RT2015-1AG61&lang=en

Characteristic: Tripping characteristics, I^2t , Let-through current

<https://support.industry.siemens.com/cs/ww/en/ps/3RT2015-1AG61/char>

Further characteristics (e.g. electrical endurance, switching frequency)

<http://www.automation.siemens.com/bilddb/index.aspx?view=Search&mlfb=3RT2015-1AG61&objecttype=14&gridview=view1>

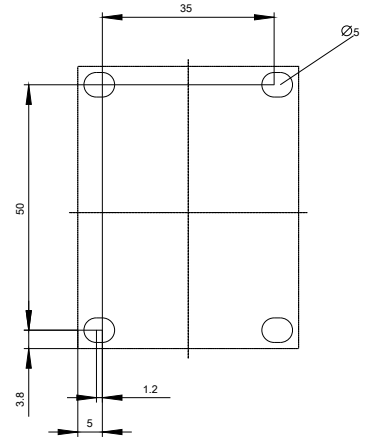
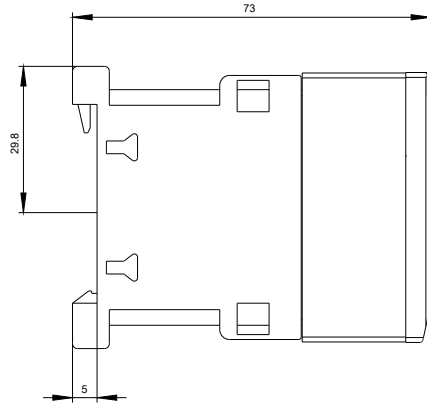
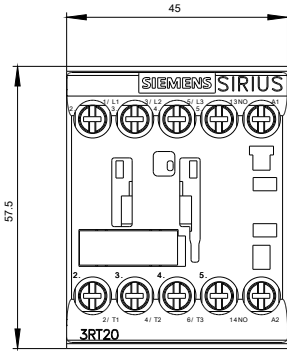

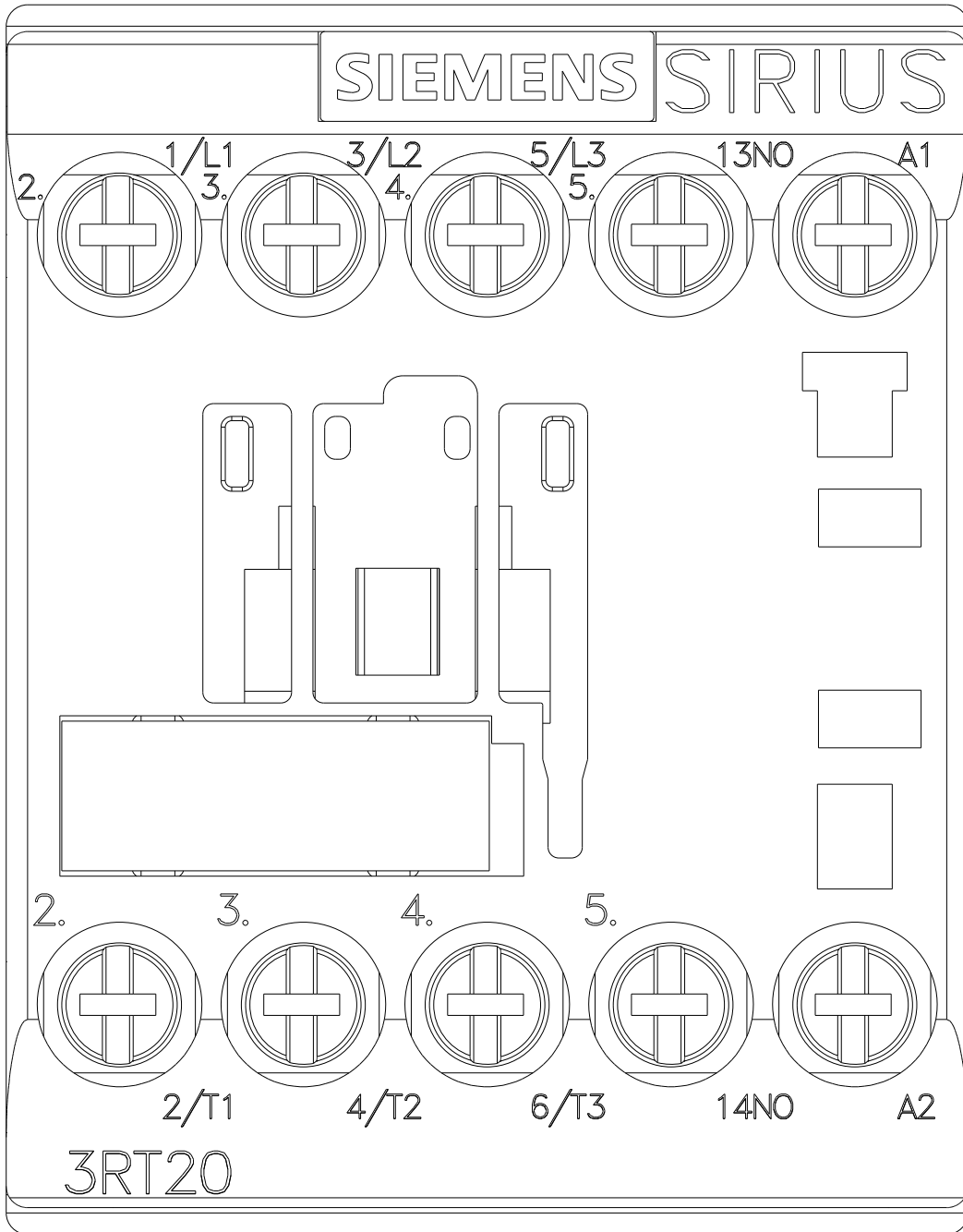

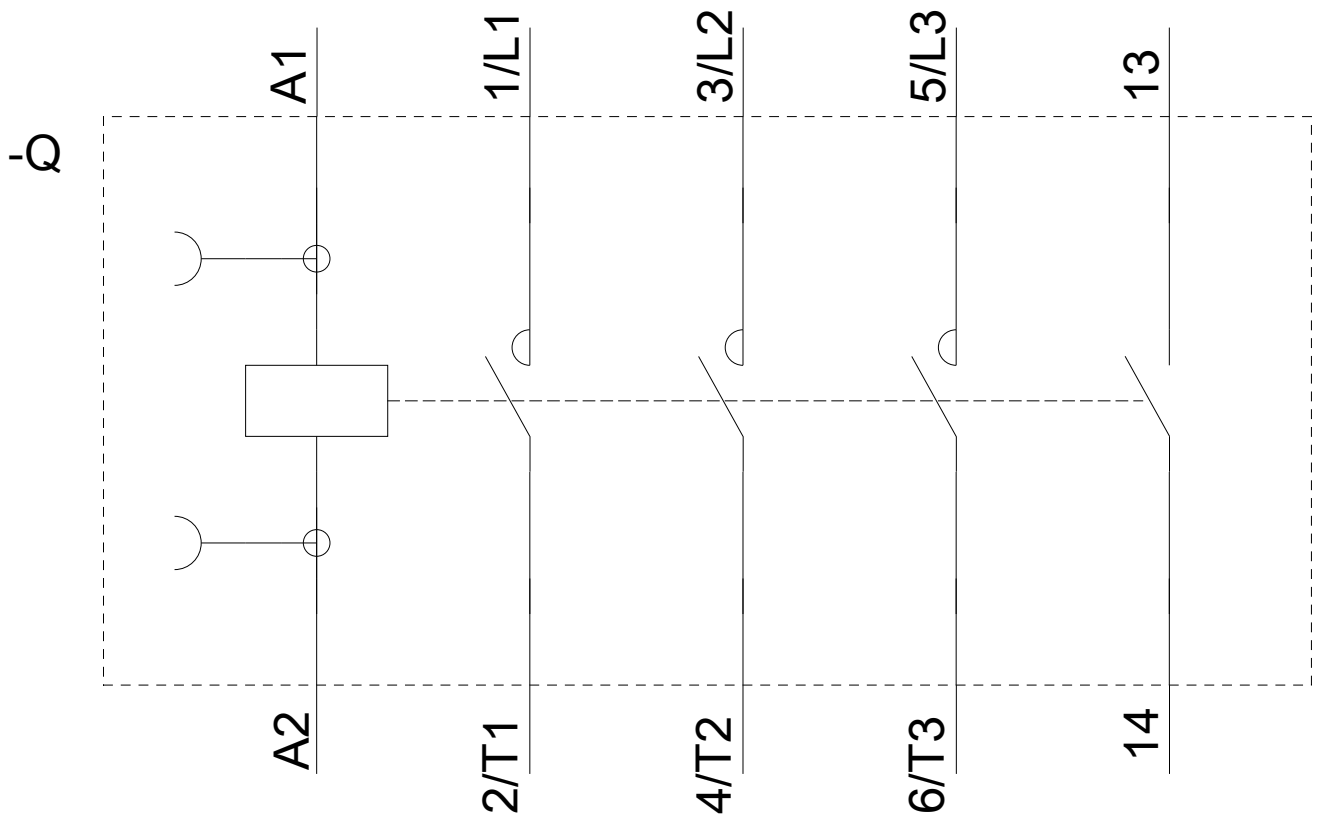

last modified:

09/24/2019