

Key for key-operated switch CES, Lock No. SSG 10



Product brand name	SIRIUS ACT
Product designation	Keys
Design of the product	CES
Product type designation	3SU1

Actuator

Key number	SSG10
-------------------	-------

Ambient conditions

Environmental category during operation acc. to IEC 60721	3M6, 3S2, 3B2, 3C3, 3K6 (with relative air humidity of 10 ... 95 %)
---	---





Installation/ mounting/ dimensions

(height)	21.5 mm
Width	2.2 mm
Depth	53.2 mm

Accessories

Material of accessory	Metal
Color of accessory	Silver

Certificates/approvals

General Product Approval			Declaration of Conformity		Test Certificates
				Miscellaneous	Special Test Certificate

Test Certificates	Marine / Shipping				
Type Test Certificates/Test Report					

Marine / Shipping	other
	Confirmation

Further information

Information- and Downloadcenter (Catalogs, Brochures,...)

<http://www.siemens.com/industrial-controls/catalogs>

Industry Mall (Online ordering system)

<https://mall.industry.siemens.com/mall/en/en/Catalog/product?mlfb=3SU1950-0FP80-0AA0>

Cax online generator

<http://support.automation.siemens.com/WW/CAXorder/default.aspx?lang=en&mlfb=3SU1950-0FP80-0AA0>

Service&Support (Manuals, Certificates, Characteristics, FAQs,...)

<https://support.industry.siemens.com/cs/ww/en/ps/3SU1950-0FP80-0AA0>

Image database (product images, 2D dimension drawings, 3D models, device circuit diagrams, EPLAN macros, ...)

http://www.automation.siemens.com/bilddb/cax_de.aspx?mlfb=3SU1950-0FP80-0AA0&lang=en

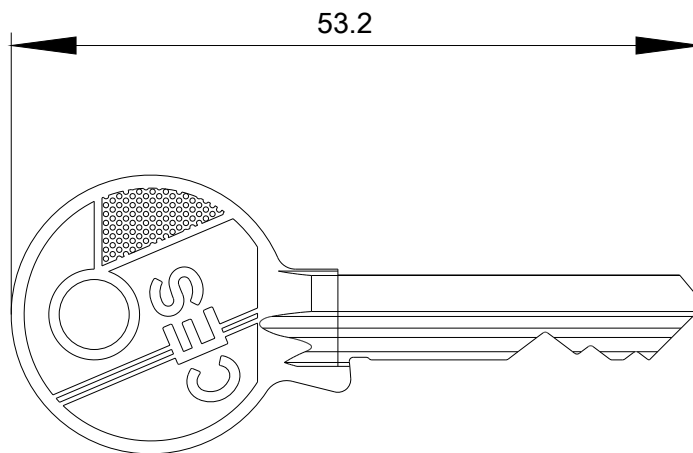
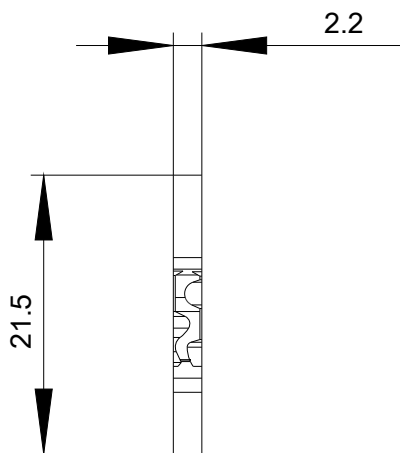

last modified:

04/29/2019