

Reversing contactor assembly AC-3, 4 kW/400 V, 24 V DC 3-pole,  
Size S00 Spring-type terminal electrical and mechanical interlock



<b>Product brand name</b>	SIRIUS
<b>Product designation</b>	Reversing contactor assembly
<b>Product type designation</b>	3RA23
<b>Manufacturer's article number</b>	<ul style="list-style-type: none"> <li>• 1 of the supplied contactor <a href="#">3RT2016-2BB42</a></li> <li>• 2 of the supplied contactor <a href="#">3RT2016-2BB42</a></li> <li>• of the supplied RH assembly kit <a href="#">3RA2913-2AA2</a></li> </ul>

General technical data	
<b>Size of contactor</b>	S00
<b>Product extension</b>	Yes
<ul style="list-style-type: none"> <li>• Auxiliary switch</li> </ul>	
<b>Insulation voltage</b>	690 V
<ul style="list-style-type: none"> <li>• with degree of pollution 3 rated value</li> </ul>	
<b>Degree of pollution</b>	3
<b>Surge voltage resistance rated value</b>	6 kV
<b>Protection class IP</b>	IP20
<ul style="list-style-type: none"> <li>• on the front</li> </ul>	
<b>Shock resistance</b>	9.8g / 5 ms and 5.9g / 10 ms
<b>Shock resistance at rectangular impulse</b>	

<ul style="list-style-type: none"> <li>• at AC</li> <li>• at DC</li> </ul>	6,7g / 5 ms, 4,2g / 10 ms 6,7g / 5 ms, 4,2g / 10 ms
<b>Shock resistance with sine pulse</b>	
<ul style="list-style-type: none"> <li>• at AC</li> <li>• at DC</li> </ul>	10,5g / 5 ms, 6,6g / 10 ms 10,5g / 5 ms, 6,6g / 10 ms
<b>Mechanical service life (switching cycles)</b>	
<ul style="list-style-type: none"> <li>• of contactor typical</li> <li>• of the contactor with added auxiliary switch block typical</li> </ul>	10 000 000 10 000 000
<b>Reference code acc. to DIN EN 81346-2</b>	Q

### Ambient conditions

<b>Installation altitude at height above sea level</b>	
<ul style="list-style-type: none"> <li>• maximum</li> </ul>	2 000 m
<b>Ambient temperature</b>	
<ul style="list-style-type: none"> <li>• during operation</li> <li>• during storage</li> </ul>	-25 ... +60 °C -55 ... +80 °C

### Main circuit

<b>Number of poles for main current circuit</b>	3
<b>Number of NO contacts for main contacts</b>	3
<b>Number of NC contacts for main contacts</b>	0
<b>Operating voltage</b>	
<ul style="list-style-type: none"> <li>• at AC-3 rated value maximum</li> </ul>	690 V
<b>Operating current</b>	
<ul style="list-style-type: none"> <li>• at AC-1 at 400 V <ul style="list-style-type: none"> <li>— at ambient temperature 40 °C rated value</li> <li>— at ambient temperature 60 °C rated value</li> </ul> </li> <li>• at AC-2 at 400 V rated value</li> <li>• at AC-3 <ul style="list-style-type: none"> <li>— at 400 V rated value</li> </ul> </li> </ul>	18 A 16 A 7 A 9 A
<b>Operating current</b>	
<ul style="list-style-type: none"> <li>• at 1 current path at DC-1 <ul style="list-style-type: none"> <li>— at 24 V rated value</li> <li>— at 110 V rated value</li> </ul> </li> <li>• with 2 current paths in series at DC-1 <ul style="list-style-type: none"> <li>— at 24 V rated value</li> <li>— at 110 V rated value</li> </ul> </li> <li>• with 3 current paths in series at DC-1 <ul style="list-style-type: none"> <li>— at 24 V rated value</li> <li>— at 110 V rated value</li> </ul> </li> </ul>	20 A 2.1 A 20 A 12 A 20 A 20 A
<b>Operating current</b>	
<ul style="list-style-type: none"> <li>• at 1 current path at DC-3 at DC-5</li> </ul>	

— at 24 V rated value	20 A
— at 110 V rated value	0.15 A
• with 2 current paths in series at DC-3 at DC-5	
— at 24 V rated value	20 A
— at 110 V rated value	0.35 A
• with 3 current paths in series at DC-3 at DC-5	
— at 24 V rated value	20 A
— at 110 V rated value	20 A
<b>Operating power</b>	
• at AC-2 at 400 V rated value	4 kW
• at AC-3	
— at 400 V rated value	4 kW
— at 500 V rated value	4.5 kW
— at 690 V rated value	5.5 kW
• at AC-4 at 400 V rated value	4 kW
<b>No-load switching frequency</b>	1 500 1/h
<b>Operating frequency</b>	
• at AC-1 maximum	1 000 1/h
• at AC-2 maximum	750 1/h
• at AC-3 maximum	750 1/h
• at AC-4 maximum	250 1/h
<b>Control circuit/ Control</b>	
<b>Type of voltage of the control supply voltage</b>	DC
<b>Control supply voltage 1</b>	
• at DC rated value	24 V
<b>Closing power of magnet coil at DC</b>	4 W
<b>Holding power of magnet coil at DC</b>	4 W
<b>Auxiliary circuit</b>	
<b>Operating current of auxiliary contacts at AC-12 maximum</b>	10 A
<b>Operating current of auxiliary contacts at AC-15</b>	
• at 230 V	6 A
• at 400 V	3 A
<b>Operating current of auxiliary contacts at DC-13</b>	
• at 24 V	10 A
• at 60 V	2 A
• at 110 V	1 A
• at 220 V	0.3 A
<b>Contact reliability of auxiliary contacts</b>	< 1 error per 100 million operating cycles
<b>UL/CSA ratings</b>	
<b>Full-load current (FLA) for three-phase AC motor</b>	

<ul style="list-style-type: none"> <li>• at 480 V rated value</li> <li>• at 600 V rated value</li> </ul>	<p>7.6 A</p> <p>9 A</p>
<b>Yielded mechanical performance [hp]</b> <ul style="list-style-type: none"> <li>• for single-phase AC motor <ul style="list-style-type: none"> <li>— at 110/120 V rated value</li> <li>— at 230 V rated value</li> </ul> </li> <li>• for three-phase AC motor <ul style="list-style-type: none"> <li>— at 200/208 V rated value</li> <li>— at 220/230 V rated value</li> <li>— at 460/480 V rated value</li> <li>— at 575/600 V rated value</li> </ul> </li> </ul>	<p>0.33 hp</p> <p>1 hp</p> <p>2 hp</p> <p>3 hp</p> <p>5 hp</p> <p>7.5 hp</p>
<b>Contact rating of auxiliary contacts according to UL</b>	<p>A600 / Q600</p>

### Short-circuit protection

<b>Design of the fuse link</b> <ul style="list-style-type: none"> <li>• for short-circuit protection of the main circuit <ul style="list-style-type: none"> <li>— with type of coordination 1 required</li> <li>— with type of assignment 2 required</li> </ul> </li> <li>• for short-circuit protection of the auxiliary switch required</li> </ul>	<p>gG NH 3NA, DIAZED 5SB, NEOZED 5SE: 35 A</p> <p>gG NH 3NA, DIAZED 5SB, NEOZED 5SE: 20 A</p> <p>fuse gG: 10 A</p>
--	--

### Installation/ mounting/ dimensions

<b>Mounting position</b>	<p>+/-180° rotation possible on vertical mounting surface; can be tilted forward and backward by +/- 22.5° on vertical mounting surface</p>
<b>Mounting type</b>	<p>screw and snap-on mounting onto 35 mm standard mounting rail</p>
<b>Height</b>	<p>84 mm</p>
<b>Width</b>	<p>90 mm</p>
<b>Depth</b>	<p>83 mm</p>
<b>Required spacing</b> <ul style="list-style-type: none"> <li>• with side-by-side mounting <ul style="list-style-type: none"> <li>— forwards</li> <li>— Backwards</li> <li>— upwards</li> <li>— downwards</li> <li>— at the side</li> </ul> </li> <li>• for grounded parts <ul style="list-style-type: none"> <li>— forwards</li> <li>— Backwards</li> <li>— upwards</li> <li>— at the side</li> <li>— downwards</li> </ul> </li> <li>• for live parts</li> </ul>	<p>6 mm</p> <p>0 mm</p> <p>6 mm</p> <p>6 mm</p> <p>6 mm</p> <p>6 mm</p> <p>6 mm</p> <p>0 mm</p> <p>6 mm</p> <p>6 mm</p> <p>6 mm</p>

— forwards	6 mm
— Backwards	0 mm
— upwards	6 mm
— downwards	6 mm
— at the side	6 mm

## Connections/Terminals

<b>Type of electrical connection</b>	
• for main current circuit	spring-loaded terminals
• for auxiliary and control current circuit	spring-loaded terminals
<b>Type of connectable conductor cross-sections</b>	
• for main contacts	
— solid	2x (0.5 ... 4 mm <sup>2</sup> )
— single or multi-stranded	2x (0,5 ... 4 mm <sup>2</sup> )
— finely stranded with core end processing	2x (0.5 ... 2.5 mm <sup>2</sup> )
— finely stranded without core end processing	2x (0.5 ... 2.5 mm <sup>2</sup> )
• at AWG conductors for main contacts	1x (20 ... 12)
<b>Type of connectable conductor cross-sections</b>	
• for auxiliary contacts	
— single or multi-stranded	2x (0,5 ... 2,5 mm <sup>2</sup> )
— finely stranded with core end processing	2x (0.5 ... 1.5 mm <sup>2</sup> )
— finely stranded without core end processing	2x (0.5 ... 1.5 mm <sup>2</sup> )
• at AWG conductors for auxiliary contacts	2x (20 ... 14)



## Safety related data

<b>B10 value</b>	
• with high demand rate acc. to SN 31920	1 000 000
<b>Proportion of dangerous failures</b>	
• with low demand rate acc. to SN 31920	40 %
• with high demand rate acc. to SN 31920	75 %
<b>Failure rate [FIT]</b>	
• with low demand rate acc. to SN 31920	100 FIT
<b>T1 value for proof test interval or service life acc. to IEC 61508</b>	20 y

## Communication/ Protocol

<b>Product function Bus communication</b>	No
<b>Protocol is supported</b>	
• AS-interface protocol	No
<b>Product function Control circuit interface with IO link</b>	No

## Certificates/approvals

General Product Approval			Declaration of Conformity	Test Certificates	
 CSA	 UL		 EG-Konf.	<a href="#">Special Test Certificate</a>	<a href="#">Type Test Certificates/Test Report</a>

Marine / Shipping					
 ABS	 BUREAU VERITAS	 GL	 LRS	 PRS	 RMRS

Marine / Shipping	other	Railway
 DNV-GL	<a href="#">Confirmation</a>	<a href="#">Vibration and Shock</a>

### Further information

**Information- and Downloadcenter (Catalogs, Brochures,...)**

<http://www.siemens.com/industrial-controls/catalogs>

**Industry Mall (Online ordering system)**

<https://mall.industry.siemens.com/mall/en/en/Catalog/product?mlfb=3RA2316-8XB30-2BB4>

**Cax online generator**

<http://support.automation.siemens.com/WW/CAXorder/default.aspx?lang=en&mlfb=3RA2316-8XB30-2BB4>

**Service&Support (Manuals, Certificates, Characteristics, FAQs,...)**

<https://support.industry.siemens.com/cs/ww/en/ps/3RA2316-8XB30-2BB4>

**Image database (product images, 2D dimension drawings, 3D models, device circuit diagrams, EPLAN macros, ...)**

[http://www.automation.siemens.com/bilddb/cax\\_de.aspx?mlfb=3RA2316-8XB30-2BB4&lang=en](http://www.automation.siemens.com/bilddb/cax_de.aspx?mlfb=3RA2316-8XB30-2BB4&lang=en)

**Characteristic: Tripping characteristics, I<sup>2</sup>t, Let-through current**

<https://support.industry.siemens.com/cs/ww/en/ps/3RA2316-8XB30-2BB4/char>

**Further characteristics (e.g. electrical endurance, switching frequency)**

<http://www.automation.siemens.com/bilddb/index.aspx?view=Search&mlfb=3RA2316-8XB30-2BB4&objecttype=14&gridview=view1>

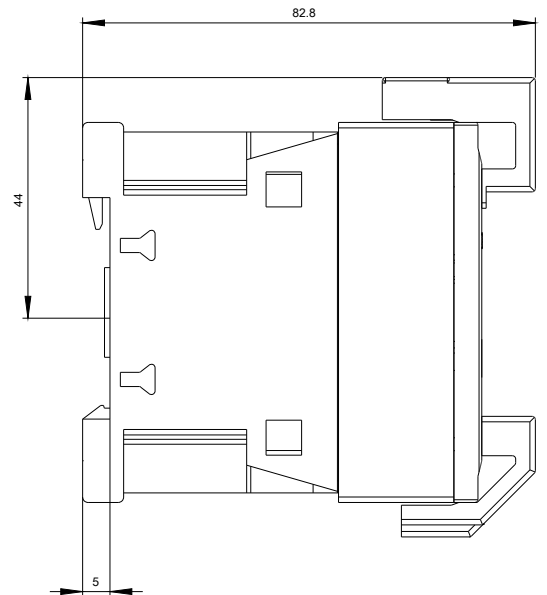
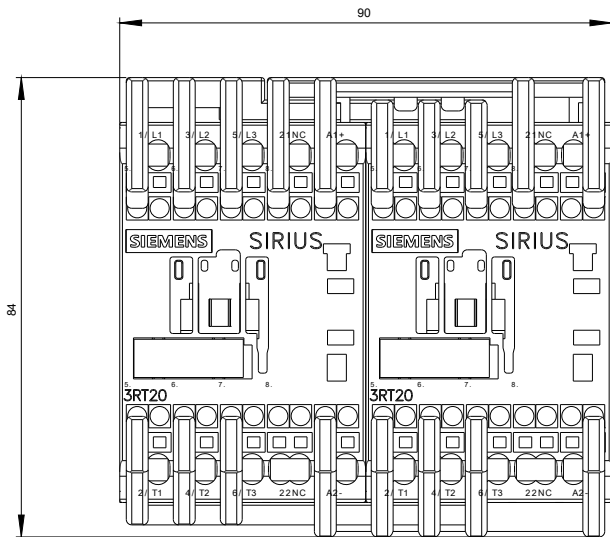

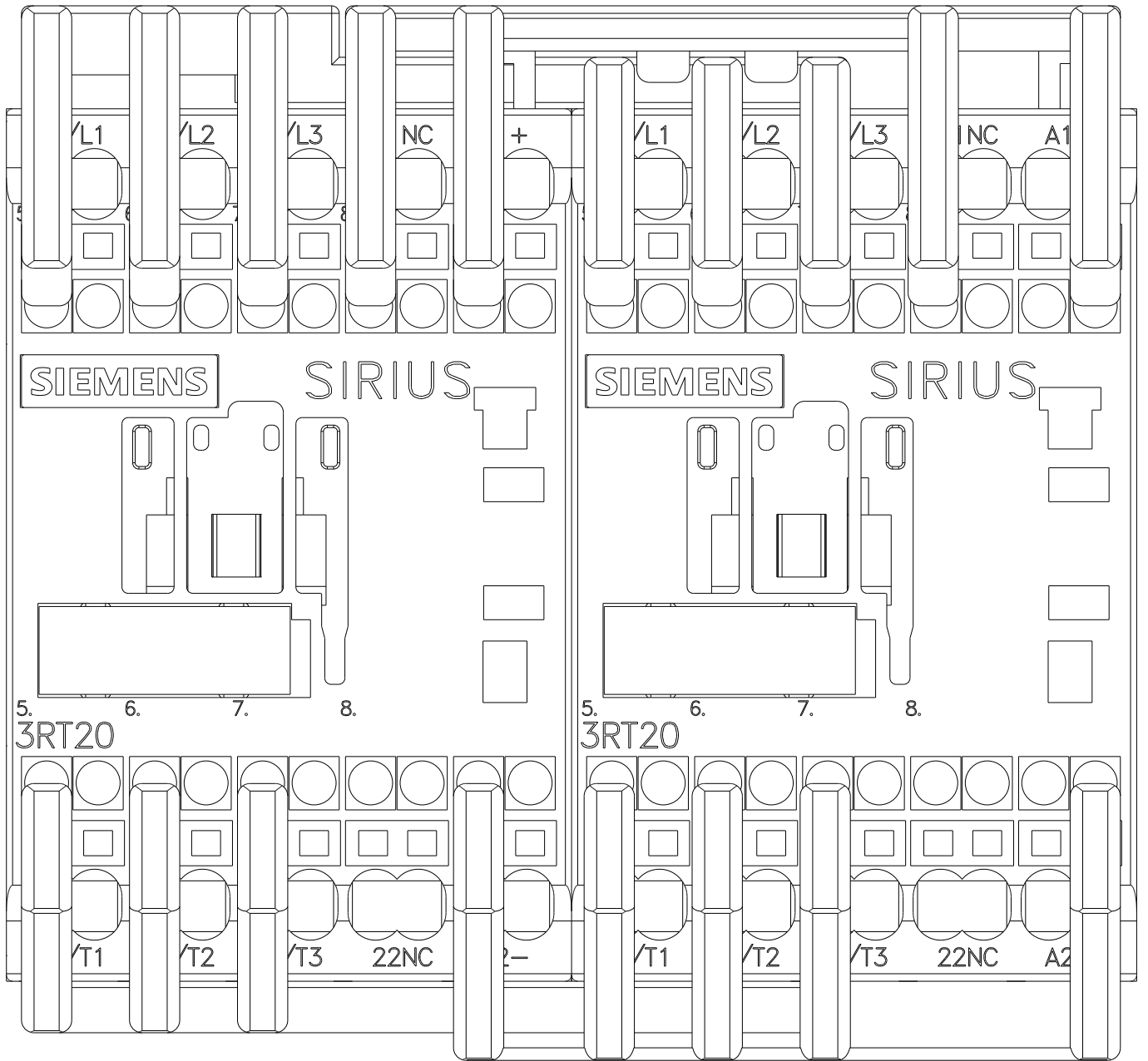



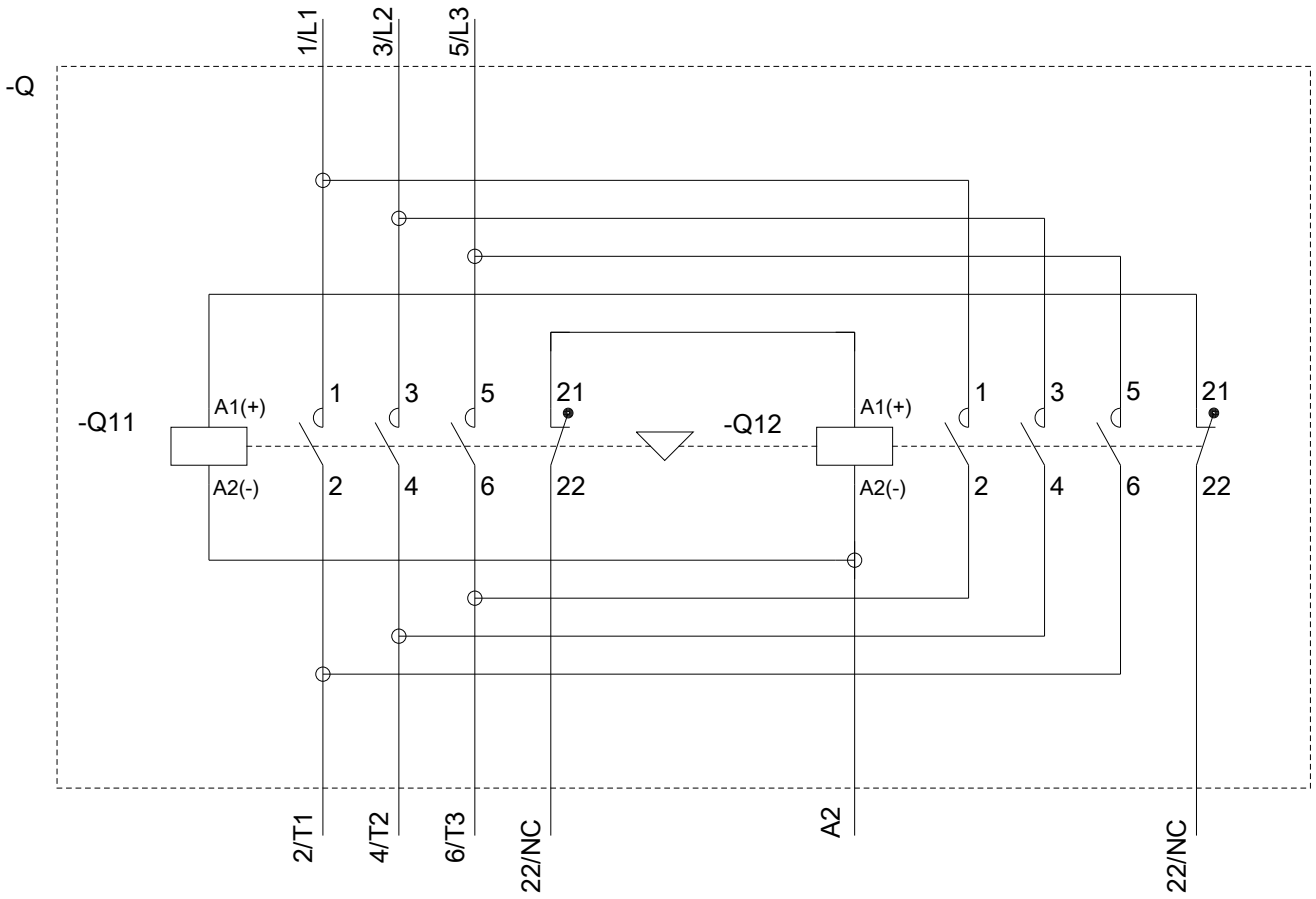

last modified:

07/16/2018