

Thermistor motor protection relay Compact evaluation unit 17.5 mm enclosure Spring-type terminal 1 change-over contact US = 24 V AC/DC Auto-reset suitable for bimetallic switch Supply =output voltage 1 LED (READY)



Figure similar

Product brand name	SIRIUS
Product category	SIRIUS 3RN2 thermistor motor protection
Product designation	Thermistor motor protection relay
Product type designation	3RN2

General technical data	
Display version LED	Yes
Power loss [W] for rated value of the current	
• at AC in hot operating state	0.5 W
• at DC in hot operating state	0.3 W
Insulation voltage	
• for overvoltage category III according to IEC 60664	
— with degree of pollution 3 rated value	300 V
Degree of pollution	3
Surge voltage resistance rated value	4 kV
Protection class IP	IP20
Shock resistance	

<ul style="list-style-type: none"> • acc. to IEC 60068-2-27 	11g / 15 ms
Vibration resistance	
<ul style="list-style-type: none"> • acc. to IEC 60068-2-6 	10 ... 55 Hz: 0.35 mm
Mechanical service life (switching cycles)	
<ul style="list-style-type: none"> • typical 	10 000 000
Electrical endurance (switching cycles)	
<ul style="list-style-type: none"> • at AC-15 at 230 V typical 	100 000
Thermal current of the switching element with contacts maximum	5 A
Reference code acc. to DIN 40719 extended according to IEC 204-2 acc. to IEC 750	K
Reference code	
<ul style="list-style-type: none"> • acc. to IEC 81346-2:2009 	K
<ul style="list-style-type: none"> • acc. to DIN EN 61346-2 	K

Control circuit/ Control	
Type of voltage of the control supply voltage	AC/DC
Control supply voltage at AC	
<ul style="list-style-type: none"> • at 50 Hz rated value 	24 ... 24 V
<ul style="list-style-type: none"> • at 60 Hz rated value 	24 ... 24 V
Control supply voltage at DC	
<ul style="list-style-type: none"> • rated value 	24 ... 24 V
Operating range factor control supply voltage rated value at DC	
<ul style="list-style-type: none"> • initial value 	0.85
<ul style="list-style-type: none"> • Full-scale value 	1.1
Operating range factor control supply voltage rated value at AC at 50 Hz	
<ul style="list-style-type: none"> • initial value 	0.85
<ul style="list-style-type: none"> • Full-scale value 	1.1
Operating range factor control supply voltage rated value at AC at 60 Hz	
<ul style="list-style-type: none"> • initial value 	0.85
<ul style="list-style-type: none"> • Full-scale value 	1.1
Inrush current peak	
<ul style="list-style-type: none"> • at 24 V 	1.8 A
Duration of inrush current peak	
<ul style="list-style-type: none"> • at 24 V 	2 ms

Measuring circuit	
Buffering time in the event of power failure minimum	40 ms
Precision	
Relative metering precision	9 %

Auxiliary circuit	
Material of switching contacts	AgSnO ₂
Number of NC contacts	0
<ul style="list-style-type: none"> • for auxiliary contacts 	0
Number of NO contacts	0
<ul style="list-style-type: none"> • for auxiliary contacts 	0
Number of CO contacts	1
<ul style="list-style-type: none"> • for auxiliary contacts 	1

Main circuit	
Operating frequency rated value	50 ... 60 Hz

Outputs	
Ampacity of the output relay at AC-15	3 A
<ul style="list-style-type: none"> • at 250 V at 50/60 Hz 	3 A
Ampacity of the output relay at DC-13	1 A
<ul style="list-style-type: none"> • at 24 V • at 125 V 	0.2 A
Continuous current of the DIAZED fuse link of the output relay	6 A

Electromagnetic compatibility	
Conducted interference	2 kV (power ports) / 1 kV (signal ports)
<ul style="list-style-type: none"> • due to burst acc. to IEC 61000-4-4 • due to conductor-earth surge acc. to IEC 61000-4-5 • due to conductor-conductor surge acc. to IEC 61000-4-5 	2 kV (line to ground)
	1 kV (line to line)
Electrostatic discharge acc. to IEC 61000-4-2	6 kV contact discharge / 8 kV air discharge

Galvanic isolation	
Design of the electrical isolation	No separation
Galvanic isolation	No
<ul style="list-style-type: none"> • between entrance and outlet • between the voltage supply and other circuits 	No

Connections/Terminals	
Product function	Yes
<ul style="list-style-type: none"> • removable terminal for auxiliary and control circuit 	Yes
Type of electrical connection	Push-in terminal
Type of connectable conductor cross-sections	0.5 ... 4 mm ²
<ul style="list-style-type: none"> • solid • finely stranded with core end processing • finely stranded without core end processing • at AWG conductors solid 	0.5 ... 2.5 mm ²
	0.5 ... 4 mm ²
	20 ... 12

<ul style="list-style-type: none"> • at AWG conductors stranded 	20 ... 12
Connectable conductor cross-section	
<ul style="list-style-type: none"> • solid 	0.5 ... 4 mm ²
<ul style="list-style-type: none"> • finely stranded with core end processing 	0.5 ... 2.5 mm ²
<ul style="list-style-type: none"> • finely stranded without core end processing 	0.5 ... 4 mm ²
AWG number as coded connectable conductor cross section	
<ul style="list-style-type: none"> • solid 	20 ... 12
<ul style="list-style-type: none"> • stranded 	20 ... 12

Installation/ mounting/ dimensions

Mounting position	any
Mounting type	screw and snap-on mounting onto 35 mm standard mounting rail
Height	100 mm
Width	17.5 mm
Depth	90 mm
Required spacing	
<ul style="list-style-type: none"> • with side-by-side mounting <ul style="list-style-type: none"> — forwards — Backwards — upwards — downwards — at the side 	0 mm 0 mm 0 mm 0 mm 0 mm
<ul style="list-style-type: none"> • for grounded parts <ul style="list-style-type: none"> — forwards — Backwards — upwards — at the side — downwards 	0 mm 0 mm 0 mm 0 mm 0 mm
<ul style="list-style-type: none"> • for live parts <ul style="list-style-type: none"> — forwards — Backwards — upwards — downwards — at the side 	0 mm 0 mm 0 mm 0 mm 0 mm

Ambient conditions

Installation altitude at height above sea level	
<ul style="list-style-type: none"> • maximum 	2 000 m
Ambient temperature	
<ul style="list-style-type: none"> • during operation 	-25 ... +60 °C
<ul style="list-style-type: none"> • during storage 	-40 ... +85 °C
<ul style="list-style-type: none"> • during transport 	-40 ... +85 °C



Relative humidity

- during operation

70 %

Certificates/approvals

General Product Approval	EMC	Declaration of Conformity
 CCC	 EAC	 EG-Konf.
 CSA	 C-Tick	
 UL		

Test Certificates	Marine / Shipping	other
Type Test Certificates/Test Report	 LRS	Confirmation
	 PRS	
	 DNVGL.COM/AF	

Further information

Information- and Downloadcenter (Catalogs, Brochures,...)

<http://www.siemens.com/industrial-controls/catalogs>

Industry Mall (Online ordering system)

<https://mall.industry.siemens.com/mall/en/en/Catalog/product?mlfb=3RN2000-2AA30>

Cax online generator

<http://support.automation.siemens.com/WW/CAXorder/default.aspx?lang=en&mlfb=3RN2000-2AA30>

Service&Support (Manuals, Certificates, Characteristics, FAQs,...)

<https://support.industry.siemens.com/cs/ww/en/ps/3RN2000-2AA30>

Image database (product images, 2D dimension drawings, 3D models, device circuit diagrams, EPLAN macros, ...)

http://www.automation.siemens.com/bilddb/cax_de.aspx?mlfb=3RN2000-2AA30&lang=en

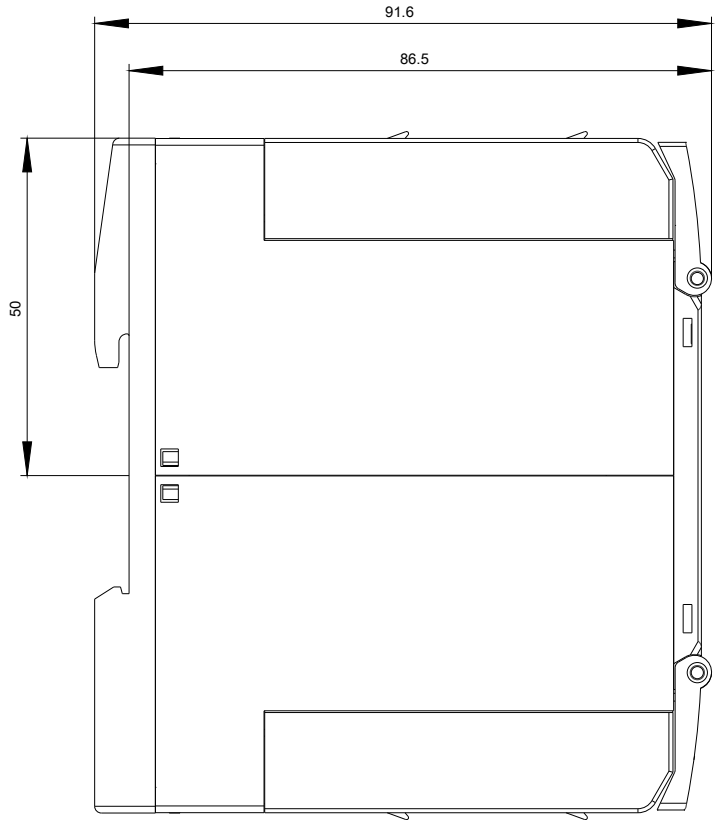
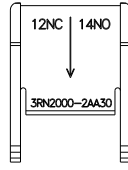
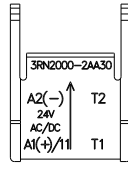
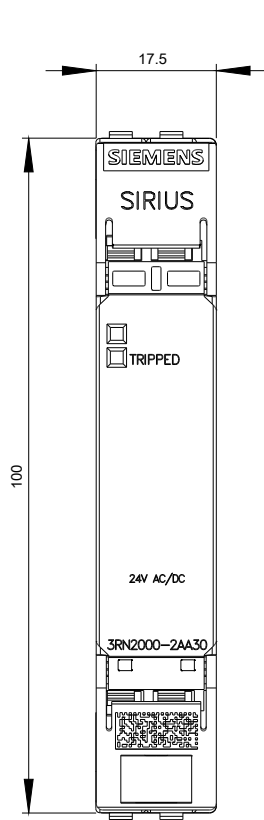

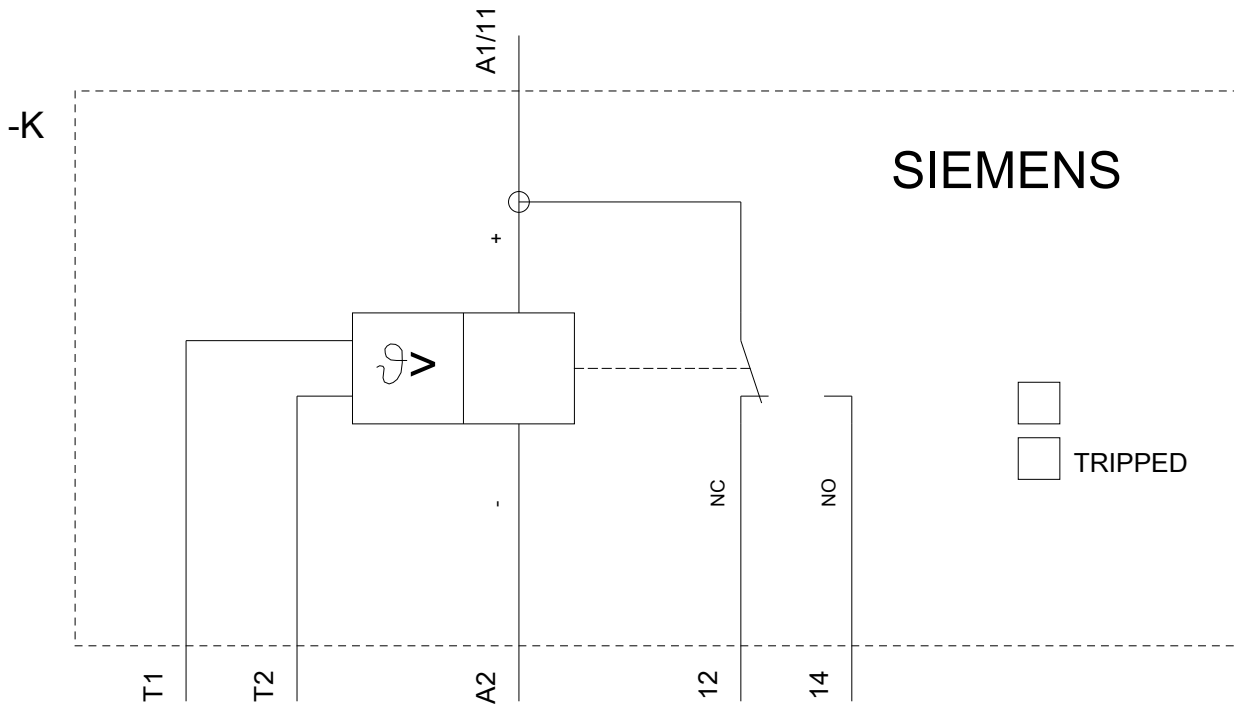

last modified:

05/17/2018