

LINK MODULE, ELECTRICAL AND MECHANICAL,
FOR 3RV1.2 AND 3RT101 FOR 3RV2.1/3RV2.2 AND
3RT2.1 AC AND DC OPERATION (SINGLE-UNIT
PACKAGING)

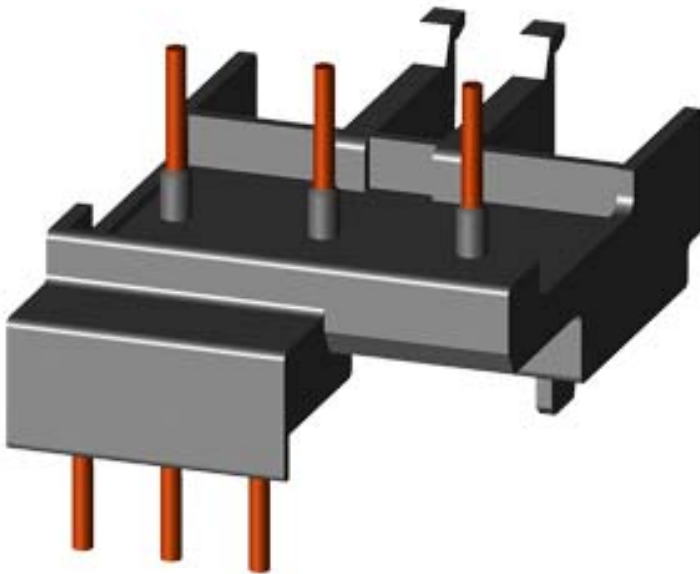

General technical data

product brandname	SIRIUS
Product designation	link module
Design of the product	for 3RV1.2 and 3RT101, for 3RV2.1/3RV2.2 and 3RT2.1
Size of the circuit-breaker	S00
Size of contactor	S00

Certificates/approvals

General Product Approval	Declaration of Conformity	Test Certificates	Shipping Approval
--------------------------	---------------------------	-------------------	-------------------



[Typprüfbescheinigung/Werkszeugnis](#)

[spezielle Prüfbescheinigungen](#)



Shipping Approval	other
-------------------	-------



[Umweltbestätigung](#)

[Bestätigungen](#)

Further information

Information- and Downloadcenter (Catalogs, Brochures,...)

<http://www.siemens.com/industrial-controls/catalogs>

Industry Mall (Online ordering system)

<https://mall.industry.siemens.com/mall/en/en/Catalog/product?mlfb=3RA1921-1DA00>

Cax online generator

<http://support.automation.siemens.com/WW/CAXorder/default.aspx?lang=en&mlfb=3RA1921-1DA00>

Service&Support (Manuals, Certificates, Characteristics, FAQs,...)

<https://support.industry.siemens.com/cs/ww/en/ps/3RA1921-1DA00>

Image database (product images, 2D dimension drawings, 3D models, device circuit diagrams, EPLAN macros, ...)

http://www.automation.siemens.com/bilddb/cax_de.aspx?mlfb=3RA1921-1DA00&lang=en

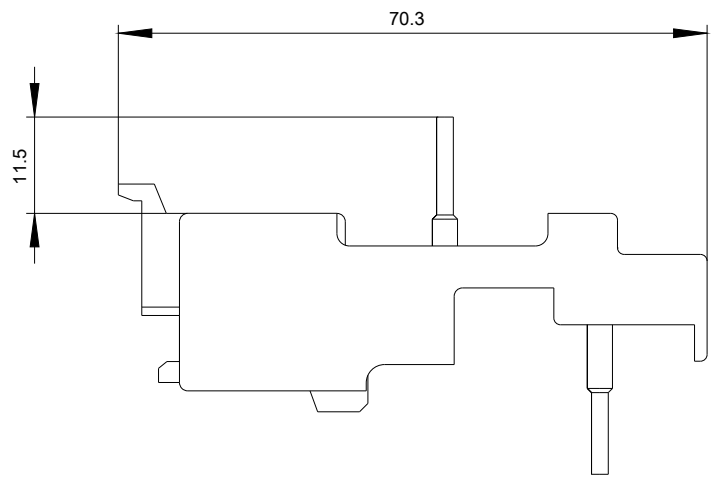
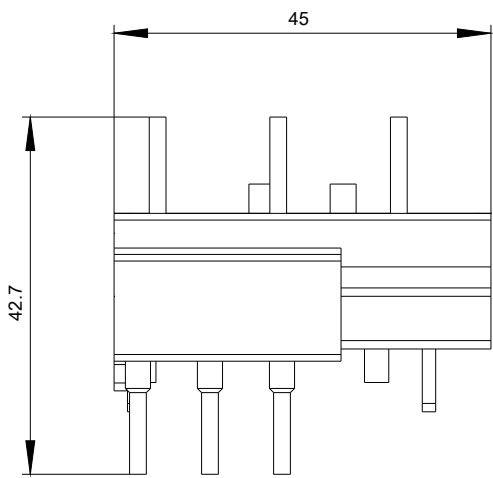

last modified:

04/05/2017