

## SITOP power supply

## LOGO!Power

### Manual

LOGO!Power 5 V/3 A  
6EP3310-6SB00-0AY0  
LOGO!Power 5 V/6.3 A  
6EP3311-6SB00-0AY0  
LOGO!Power 12 V/0.9 A  
6EP3320-6SB00-0AY0  
LOGO!Power 12 V/1.9 A  
6EP3321-6SB00-0AY0  
LOGO!Power 12 V/4.5 A  
6EP3322-6SB00-0AY0  
LOGO!Power 15 V/1.9 A  
6EP3321-6SB10-0AY0  
LOGO!Power 15 V/4 A  
6EP3322-6SB10-0AY0  
LOGO!Power 24 V/0.6 A  
6EP3330-6SB00-0AY0  
LOGO!Power 24 V/1.3 A  
6EP3331-6SB00-0AY0  
LOGO!Power 24 V/2.5 A  
6EP3332-6SB00-0AY0  
LOGO!Power 24 V/4 A  
6EP3333-6SB00-0AY0

06.2017

A5E40912965-1-76

### Overview

---

Safety instructions

1

Description, device design,  
dimension drawing

2

Mounting/removal

3

Mounting position, mounting  
clearances

4

Installation

5

Technical data

6

Safety, approvals, EMC

7

Ambient conditions

8

Applications

9

Environment

10

Service & Support

11

## Legal information

### Warning notice system

This manual contains notices you have to observe in order to ensure your personal safety, as well as to prevent damage to property. The notices referring to your personal safety are highlighted in the manual by a safety alert symbol, notices referring only to property damage have no safety alert symbol. These notices shown below are graded according to the degree of danger.

#### **DANGER**

indicates that death or severe personal injury **will** result if proper precautions are not taken.

#### **WARNING**

indicates that death or severe personal injury **may** result if proper precautions are not taken.

#### **CAUTION**

indicates that minor personal injury can result if proper precautions are not taken.

#### **NOTICE**

indicates that property damage can result if proper precautions are not taken.

If more than one degree of danger is present, the warning notice representing the highest degree of danger will be used. A notice warning of injury to persons with a safety alert symbol may also include a warning relating to property damage.

### Qualified Personnel

The product/system described in this documentation may be operated only by **personnel qualified** for the specific task in accordance with the relevant documentation, in particular its warning notices and safety instructions. Qualified personnel are those who, based on their training and experience, are capable of identifying risks and avoiding potential hazards when working with these products/systems.

### Proper use of Siemens products

Note the following:

#### **WARNING**

Siemens products may only be used for the applications described in the catalog and in the relevant technical documentation. If products and components from other manufacturers are used, these must be recommended or approved by Siemens. Proper transport, storage, installation, assembly, commissioning, operation and maintenance are required to ensure that the products operate safely and without any problems. The permissible ambient conditions must be complied with. The information in the relevant documentation must be observed.

### Trademarks

All names identified by ® are registered trademarks of Siemens AG. The remaining trademarks in this publication may be trademarks whose use by third parties for their own purposes could violate the rights of the owner.

### Disclaimer of Liability

We have reviewed the contents of this publication to ensure consistency with the hardware and software described. Since variance cannot be precluded entirely, we cannot guarantee full consistency. However, the information in this publication is reviewed regularly and any necessary corrections are included in subsequent editions.

# Overview



Figure 1 View of devices

LOGO!Power are powerful power supplies that can be extremely flexibly used in a host of applications – in installation distribution boards for example – as a result of their flat, stepped profile. The 12 V and 24 V versions are ideal as power supplies for the LOGO! logic modules.

The key benefits of the product include:

- Reduced widths, and therefore the narrowest device available in the market in its power class
- Power loss in no-load operation (standby) <0.3 W
- Briefly (i.e. up to 1sec) up to AC 300 V at the input
- Operation with a DC voltage from 110 - 300 V DC

- Improved efficiency across the entire load range
- Power reserve of 150 % (typ. 200 ms) for capacitive loads when the power supply runs up
- Measuring point for actual output current
- Extended operating temperature range from -25 °C up to +70 °C (derating from 55 °C)
- Standard rail and wall mounting

## Ordering data

The following device options are available:

LOGO!Power stabilized power supply	
Type	Order number
Input 85 to 264 V AC 110 to 300 V DC Output 5 V DC/3 A	6EP3310-6SB00-0AY0
Input 85 to 264 V AC 110 to 300 V DC Output 5 V DC/6.3 A	6EP3311-6SB00-0AY0
Input 85 to 264 V AC 110 to 300 V DC Output 12 V DC/0.9 A	6EP3320-6SB00-0AY0
Input 85 to 264 V AC 110 to 300 V DC Output 12 V DC/1.9 A	6EP3321-6SB00-0AY0
Input 85 to 264 V AC 110 to 300 V DC Output 12 V DC/4.5 A	6EP3322-6SB00-0AY0
Input 85 to 264 V AC 110 to 300 V DC Output 15 V DC/1.9 A	6EP3321-6SB10-0AY0
Input 85 to 264 V AC 110 to 300 V DC Output 15 V DC/4 A	6EP3322-6SB10-0AY0
Input 85 to 264 V AC 110 to 300 V DC Output, 24 V DC/0.6 A	6EP3330-6SB00-0AY0
Input 85 to 264 V AC 110 to 300 V DC Output 24 V DC/1.3 A	6EP3331-6SB00-0AY0
Input 85 to 264 V AC 110 to 300 V DC Output 24 V DC/2.5 A	6EP3332-6SB00-0AY0
Input 85 to 264 V AC 110 to 300 V DC Output 24 VDC/4 A	6EP3333-6SB00-0AY0

# Table of contents

	<b>Overview.....</b>	<b>3</b>
<b>1</b>	<b>Safety instructions.....</b>	<b>7</b>
<b>2</b>	<b>Description, device design, dimension drawing.....</b>	<b>9</b>
2.1	Device description.....	9
2.2	Connections and terminal designation.....	11
2.3	Potentiometer.....	13
2.4	Status displays and signaling .....	14
2.5	Block diagram .....	16
2.6	Dimensions and weight.....	17
<b>3</b>	<b>Mounting/removal .....</b>	<b>21</b>
<b>4</b>	<b>Mounting position, mounting clearances.....</b>	<b>23</b>
4.1	Standard mounting position .....	23
4.2	Other mounting positions.....	28
4.2.1	6EP3310-6SB00-0AY0 (5V 3A).....	28
4.2.2	6EP3311-6SB00-0AY0 (5V 6.3A).....	30
4.2.3	6EP3320-6SB00-0AY0 (12V 0.9A).....	32
4.2.4	6EP3321-6SB00-0AY0 (12V 1.9A).....	34
4.2.5	6EP3322-6SB00-0AY0 (12V 4.5A).....	36
4.2.6	6EP3321-6SB10-0AY0 (15V 1.9A).....	38
4.2.7	6EP3322-6SB10-0AY0 (15V 4A).....	40
4.2.8	6EP3330-6SB00-0AY0 (24V 0.6A).....	42
4.2.9	6EP3331-6SB00-0AY0 (24V 1.3A).....	44
4.2.10	6EP3332-6SB10-0AY0 (24V 2.5A).....	46
4.2.11	6EP3333-6SB00-0AY0 (24V 4A).....	48
<b>5</b>	<b>Installation .....</b>	<b>51</b>
5.1	Line-side connection .....	51
5.2	Output-side connection .....	53
<b>6</b>	<b>Technical data .....</b>	<b>55</b>
6.1	Input .....	55
6.2	Output .....	58
6.3	Efficiency and power loss .....	63
6.4	Closed-loop control.....	69
6.5	Protection and monitoring.....	70
6.6	MTBF .....	71
6.7	Mechanical system .....	72

6.8	Dimension drawing .....	73
<b>7</b>	<b>Safety, approvals, EMC .....</b>	<b>75</b>
7.1	Safety .....	75
7.2	Test voltage.....	76
7.3	Certifications .....	77
7.4	EMC .....	78
<b>8</b>	<b>Ambient conditions.....</b>	<b>79</b>
<b>9</b>	<b>Applications .....</b>	<b>81</b>
9.1	Parallel connection to increase power rating .....	81
9.2	Parallel connection for redundancy .....	83
9.3	Series connection for increased voltage.....	84
9.4	Protection against short-time voltage dips.....	85
<b>10</b>	<b>Environment .....</b>	<b>87</b>
<b>11</b>	<b>Service &amp; Support.....</b>	<b>89</b>

# Safety instructions

# 1

 **WARNING**

**Correct handling of the devices**

When operating electrical devices, it is inevitable that certain components will carry dangerous voltages.

Therefore, failure to handle the units properly can result in death or serious physical injury as well as extensive property damage.

Only appropriately qualified personnel may work on or in the vicinity of this equipment.

Perfect, safe, and reliable operation of this equipment is dependent on proper transportation, storage, installation and mounting.

Before installation or maintenance work can begin, the system's main switch must be switched off and measures taken to prevent it being switched on again.

If this instruction is not observed, touching live parts can result in death or serious injury.





## Description, device design, dimension drawing

### 2.1 Device description

LOGO!Power are primary switched-mode power supplies for connection to a 1-phase AC system or to DC systems. An electronically regulated DC voltage that can be set via a potentiometer is available at the output of the device. The output of the device is isolated, no-load proof and short-circuit proof. The LED display indicates the operating status.

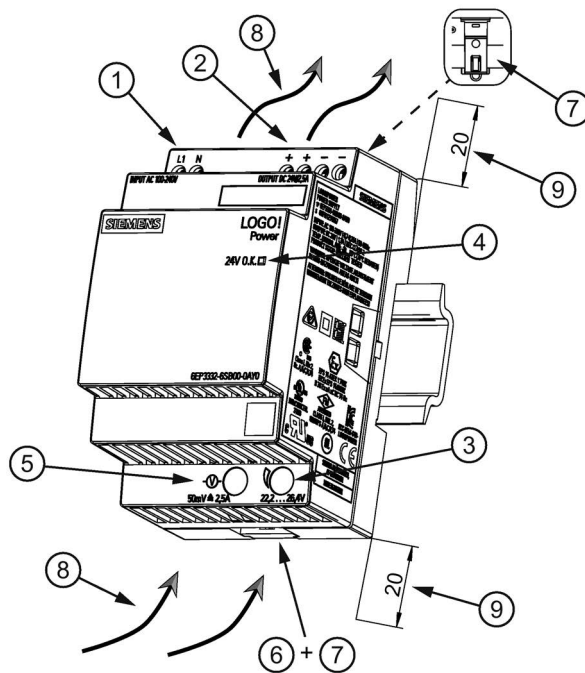

- ① AC input (optionally, also DC input)
- ② DC output
- ③ Potentiometer
- ④ Pilot lamp
- ⑤ Measuring point (for output current)
- ⑥ DIN rail slider
- ⑦ Withdrawable mounting lugs
- ⑧ Convection
- ⑨ Clearance above/below

Figure 2-1 Design 36 mm, 54 mm and 72 mm devices (example 6EP3332-6SB00-0AY0)

2.1 Device description

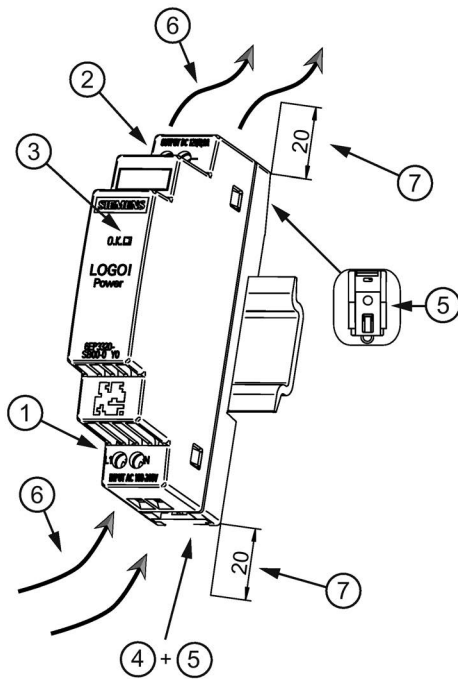

- ① AC input (optionally, also DC input)
- ② DC output
- ③ Pilot lamp
- ④ DIN rail slider
- ⑤ Withdrawable mounting lugs
- ⑥ Convection
- ⑦ Clearance above/below

Figure 2-2 Design 18 mm devices (example 6EP3320-6SB00-0AY0)

## 2.2 Connections and terminal designation





### Note

UL requirement: Use suitable copper cables that are designed for operating temperatures of at least 65 °C/75 °C.

The line input terminals ① can be used to establish the connection to supply voltage. The output terminals ② are used to connect to the loads to be supplied (see also Section Installation (Page 51)).

For 6EP3310-6SB00-0AY0, 6EP3311-6SB00-0AY0, 6EP3321-6SB00-0AY0, 6EP3322-6SB00-0AY0, 6EP3321-6SB10-0AY0, 6EP3322-6SB10-0AY0, 6EP3331-6SB00-0AY0, 6EP3332-6SB00-0AY0 and 6EP3333-6SB00-0AY0

Connections and terminal designations	
① Line input L1, N	One screw terminal each
② Output +	Two screw terminals
② Output -	Two screw terminals

	① + ②	③
	0,5 x 3 max. Ø 3,5 mm	0,4 x 2 / PZ0 / PH0 max. Ø 3,5 mm
	1 x 0,05 - 2,5 mm <sup>2</sup>	-
	1 x 0,05 - 2,5 mm <sup>2</sup>	-
AWG	30 - 12	-
Nm	0,5 - 0,6 Nm ( 4.4 lbf in )	0,04 Nm ( 0.35 lbf in ) <sup>*1)</sup>
	5,5 - 6,5 mm	-

\*1) Do not subject the end stop to higher loads

Figure 2-3 Terminal data

For 6EP3320-6SB00-0AY0 and 6EP3330-6SB00-0AY0

Connections and terminal designations	
① Line input L1, N	One screw terminal each
② Output +	One screw terminal
② Output -	One screw terminal



	① + ②
	0,5 x 3
	1 x 0,14 - 2,5 mm <sup>2</sup>
	1 x 0,14 - 2,5 mm <sup>2</sup>
AWG	26 - 14
Nm	0,5 - 0,6 Nm
	8 mm

Figure 2-4 Terminal data

## 2.3 Potentiometer

The potentiometer ③ on the front of the device is used to set the output voltage. The output voltage is set to the rated value at the factory and can be set within certain limits; for example, to compensate voltage drops across long supply lines to the connected load.

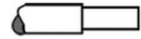
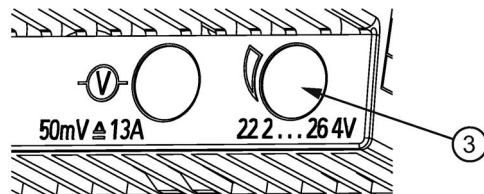

Figure 2-5 Potentiometer (example 6EP3332-6SB00-0AY0)

Type	Factory setting	Setting range
6EP3310-6SB00-0AY0 (5 V/3 A) 6EP3311-6SB00-0AY0 (5 V/6.3 A)	5 V	4.6 - 5.4 V
6EP3321-6SB00-0AY0 (12 V/1.9 A) 6EP3322-6SB00-0AY0 (12 V/4.5 A)	12 V	10.5 - 16.1 V
6EP3321-6SB10-0AY0 (15 V/1.9 A) 6EP3322-6SB10-0AY0 (15 V/4 A)	15 V	10.5 - 16.1 V
6EP3331-6SB00-0AY0 (24 V/1.3 A) 6EP3332-6SB00-0AY0 (24 V/2.5 A) 6EP3333-6SB00-0AY0 (24 V/4 A)	24 V	22.2 - 26.4 V
6EP3320-6SB00-0AY0 (12 V/0.9 A) 6EP3330-6SB00-0AY0 (24 V/0.6 A)	12 V 24 V	no setting possible

### NOTICE

#### Thermal overload possible

When adjusting the output voltage to > 24 V/> 15 V/> 12 V or > 5 V, the output current must be derated. It is not permissible that the maximum active power that can be output is exceeded.

### Note

Actuation of the potentiometer is allowed only by means of an insulated screwdriver.

For notes on actuating the potentiometer (screwdriver, torque), see Figure 2-3 Terminal data (Page 11).

## 2.4 Status displays and signaling

	6EP3310-6SB00-0AY0 (5 V/3 A)	6EP3322-6SB10-0AY0 (15 V/4 A)
	6EP3311-6SB00-0AY0 (5 V/6.3 A)	6EP3330-6SB00-0AY0 (24 V/0.6 A)
	6EP3320-6SB00-0AY0 (12 V/0.9 A)	6EP3331-6SB00-0AY0 (24 V/1.3 A)
	6EP3321-6SB00-0AY0 (12 V/1.9 A)	6EP3332-6SB00-0AY0 (24 V/2.5 A)
	6EP3322-6SB00-0AY0 (12 V/4.5 A)	6EP3333-6SB00-0AY0 (24 V/4 A)
	6EP3321-6SB10-0AY0 (15 V/1.9 A)	
Status display	Green LED for output voltage OK	

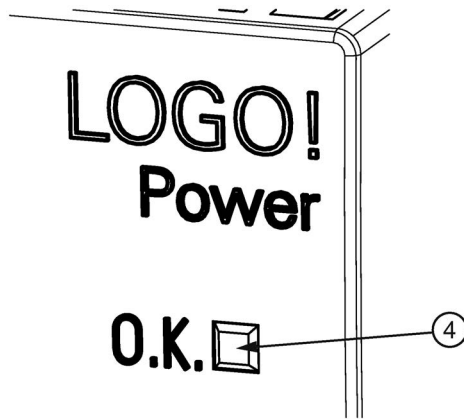

Figure 2-6 Status displays and signaling

Signaling	6EP3310-6SB00-0AY0 (5 V/3 A)	6EP3322-6SB10-0AY0 (15 V/4 A)
	6EP3311-6SB00-0AY0 (5 V/6.3 A)	6EP3330-6SB00-0AY0 (24 V/0.6 A)
	6EP3320-6SB00-0AY0 (12 V/0.9 A)	6EP3331-6SB00-0AY0 (24 V/1.3 A)
	6EP3321-6SB00-0AY0 (12 V/1.9 A)	6EP3332-6SB00-0AY0 (24 V/2.5 A)
	6EP3322-6SB00-0AY0 (12 V/4.5 A)	6EP3333-6SB00-0AY0 (24 V/4 A)
	6EP3321-6SB10-0AY0 (15 V/1.9 A)	
	LED ④ lights up green	Normal operation, output voltage present
LED ④ off	Output voltage not present	

### Measuring point for output current

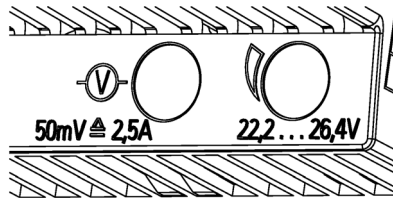

Figure 2-7 Measuring point (for output current) and setting  $U_{out}$

The measuring point (for max.  $\varnothing$  2.5 mm test probe) at the front side of the device is used to measure the output current. The voltage between the measuring point and the "-" terminal is proportional to the output current: refer to the table below

Device	$I_{out\ rated}$	Measuring point
6EP3310-6SB00-0AY0 (5 V/3 A)	3 A	~ 50 mV $\pm$ 3 A
6EP3311-6SB00-0AY0 (5 V/6.3 A)	6.3 A	~ 50 mV $\pm$ 6.3 A
6EP3320-6SB00-0AY0 (12 V/0.9 A)	0.9 A	-
6EP3321-6SB00-0AY0 (12 V/1.9 A)	1.9 A	~ 50 mV $\pm$ 1.9 A
6EP3322-6SB00-0AY0 (12 V/4.5 A)	4.5 A	~ 50 mV $\pm$ 4.5 A
6EP3321-6SB10-0AY0 (15 V/1.9 A)	1.9 A	~ 50 mV $\pm$ 1.9 A
6EP3322-6SB10-0AY0 (15 V/4 A)	4 A	~ 45 mV $\pm$ 4 A
6EP3330-6SB00-0AY0 (24 V/0.6 A)	0.6 A	-
6EP3331-6SB00-0AY0 (24 V/1.3 A)	1.3 A	~ 50 mV $\pm$ 1.3 A
6EP3332-6SB00-0AY0 (24 V/2.5 A)	2.5 A	~ 50 mV $\pm$ 2.5 A
6EP3333-6SB00-0AY0 (24 V/4 A)	4 A	~ 50 mV $\pm$ 4 A

2.5 Block diagram

### 2.5 Block diagram

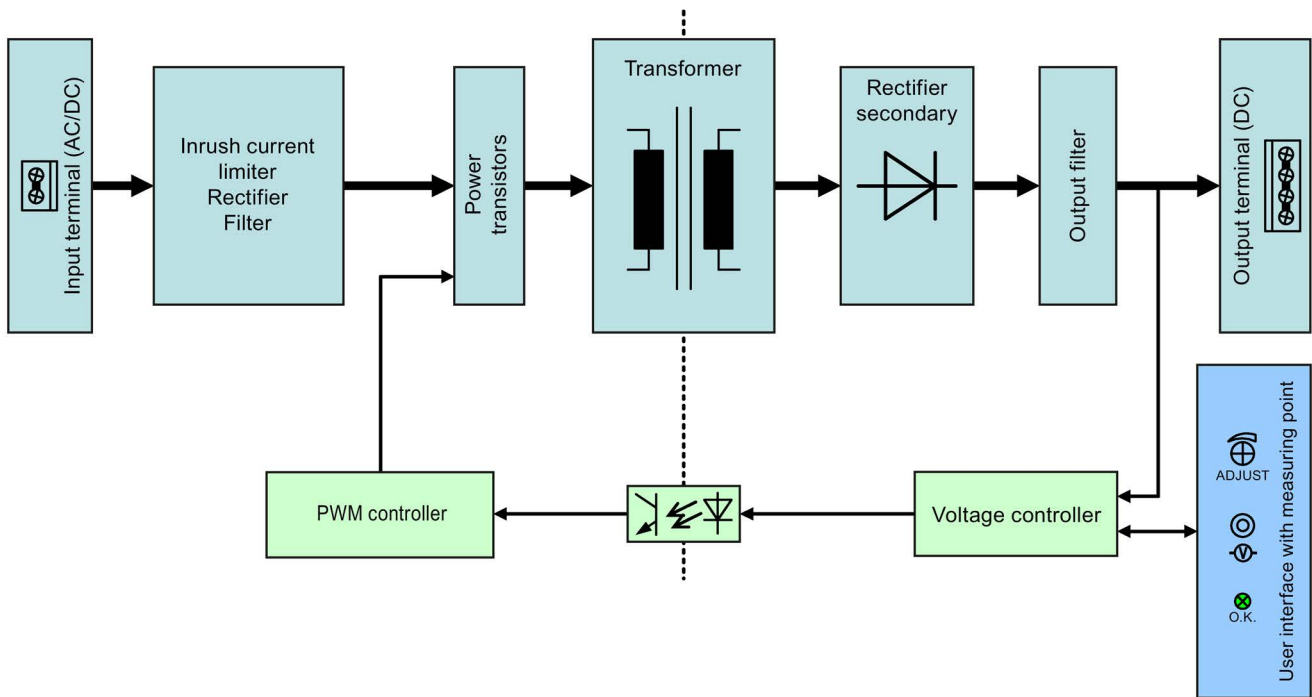

Figure 2-8 Block diagram for 36 mm, 54 mm and 72 mm devices

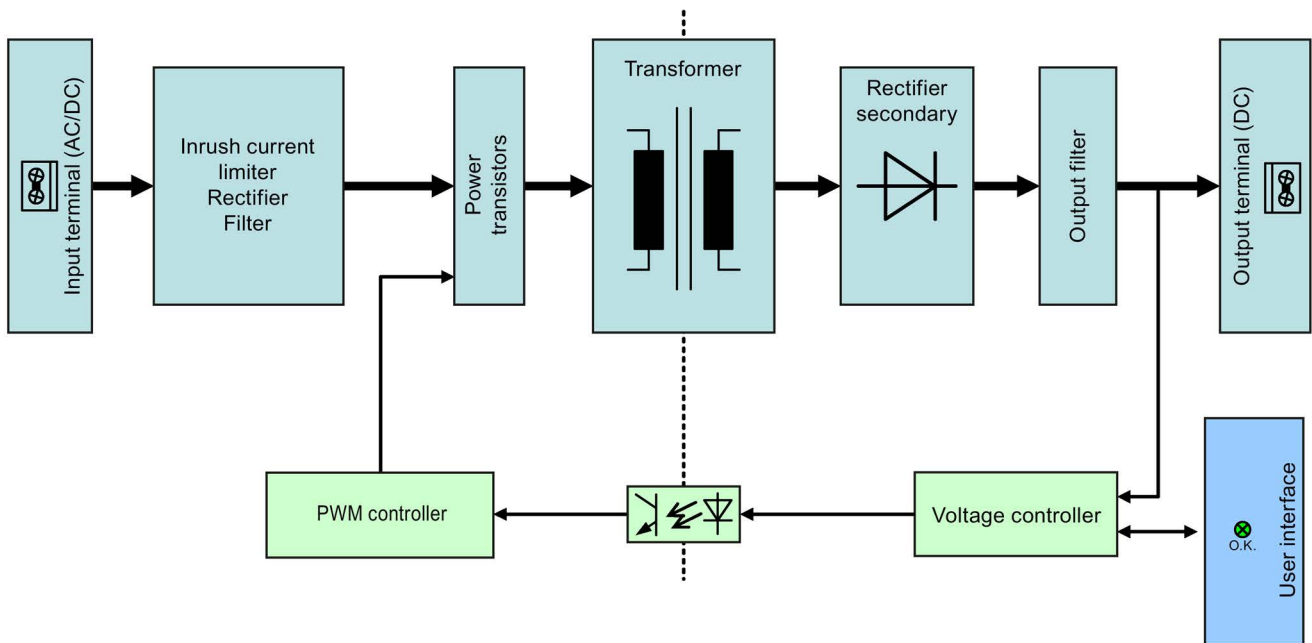

Figure 2-9 Block diagram for 18 mm devices



## 2.6 Dimensions and weight

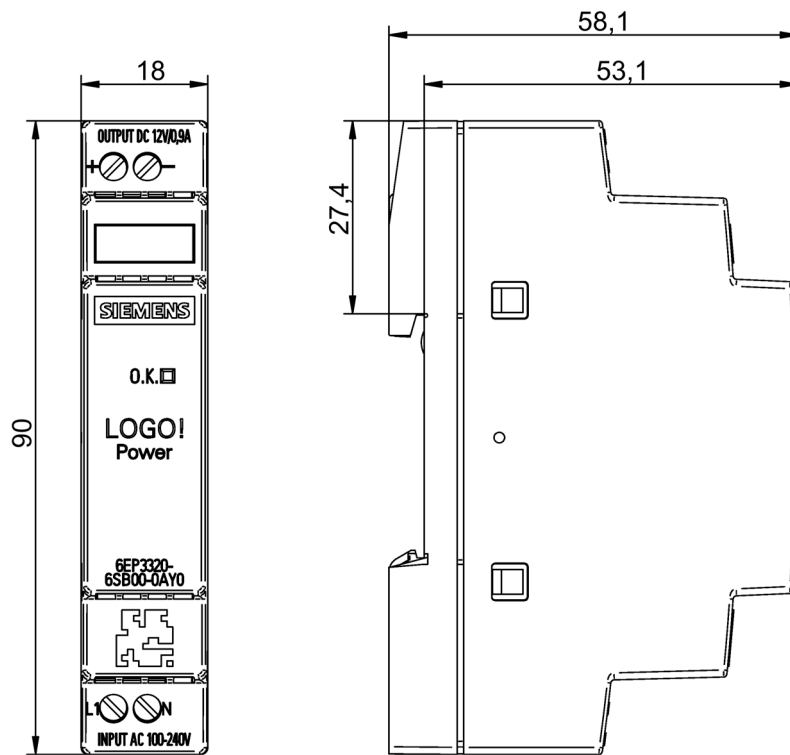

Figure 2-10 Dimension drawing for 6EP3320-6SB00-0AY0 and 6EP3330-6SB00-0AY0

2.6 Dimensions and weight

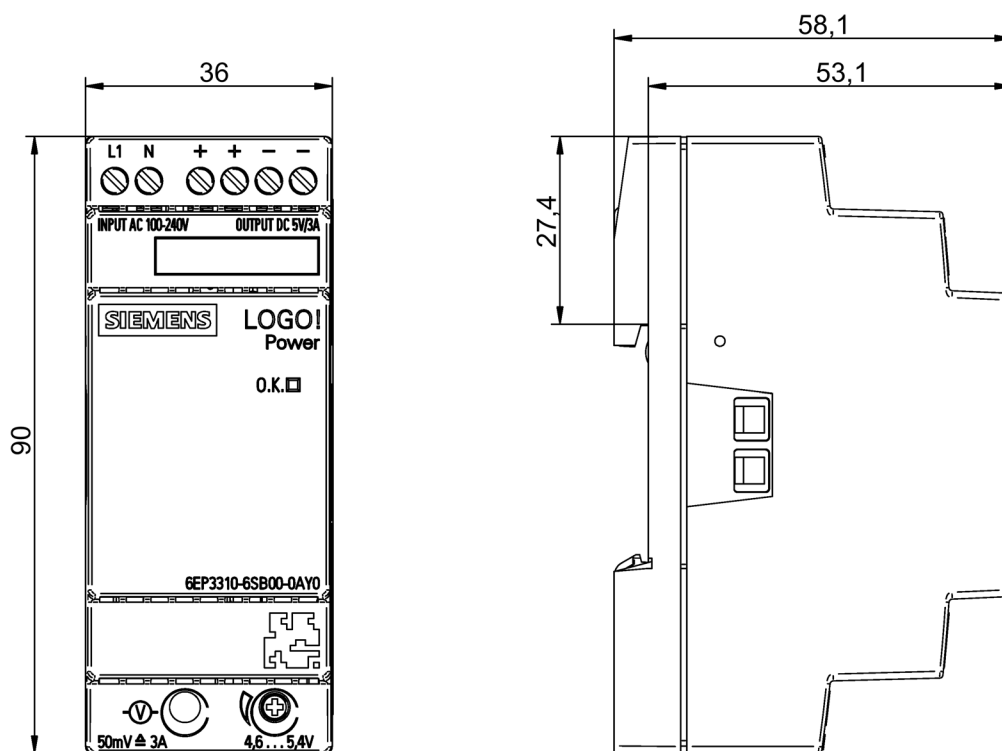

Figure 2-11 Dimension drawing for 6EP3310-6SB00-0AY0, 6EP3321-6SB00-0AY0, 6EP3321-6SB10-0AY0 and EP3331-6SB00-0AY0

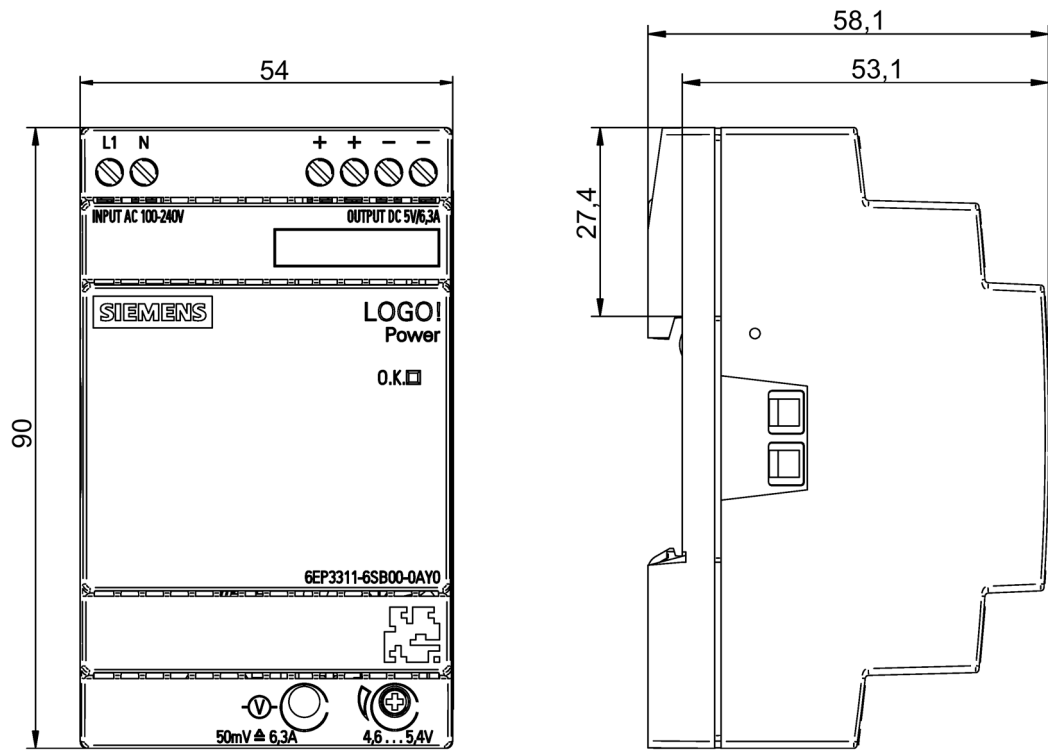

Figure 2-12 Dimension drawing for 6EP3311-6SB00-0AY0, 6EP3322-6SB00-0AY0, 6EP3322-6SB10-0AY0 and 6EP3332-6SB00-0AY0

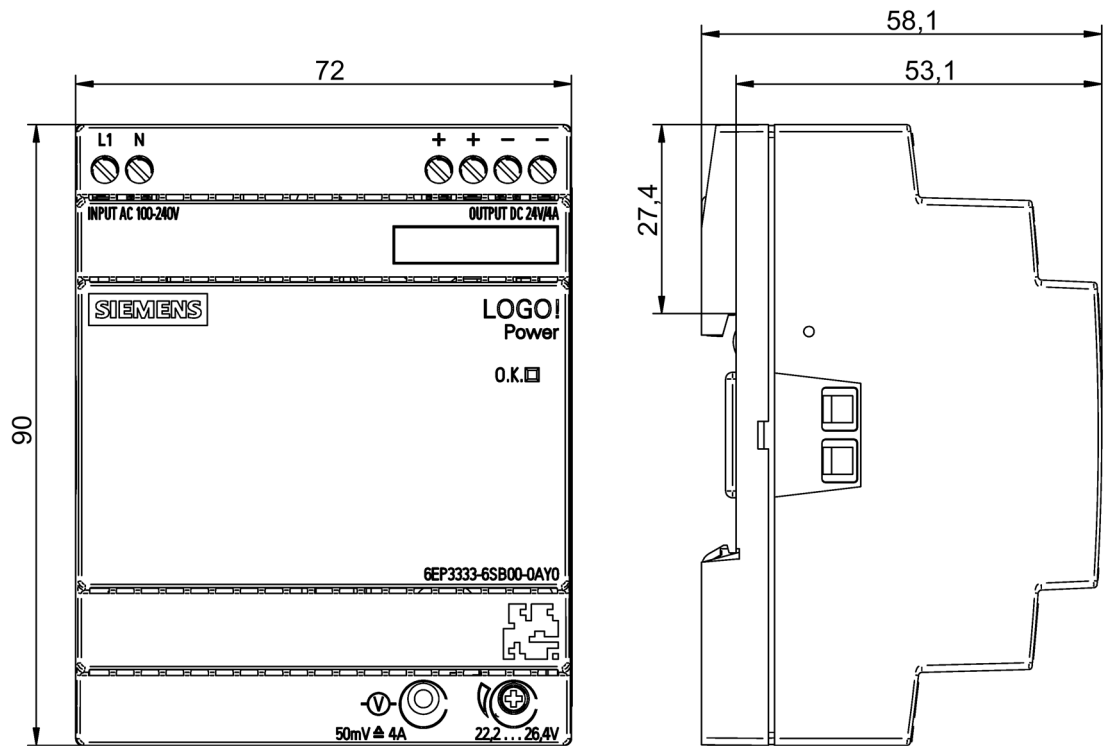

Figure 2-13 Dimension drawing for 6EP3333-6SB00-0AY0

2.6 Dimensions and weight

	6EP3320-6SB00-0AY0 (12 V/0.9 A)	6EP3310-6SB00-0AY0 (5 V/3 A)	6EP3311-6SB00-0AY0 (5 V/6.3 A)	6EP3333-6SB00-0AY0 (24 V/4 A)
	6EP3330-6SB00-0AY0 (24 V/0.6 A)	6EP3321-6SB00-0AY0 (12 V/1.9 A)	6EP3322-6SB00-0AY0 (12 V/4.5 A)	
		6EP3321-6SB10-0AY0 (15 V/1.9 A)	6EP3322-6SB10-0AY0 (15 V/4 A)	
		6EP3331-6SB00-0AY0 (24 V/1.3 A)	6EP3332-6SB00-0AY0 (24 V/2.5 A)	
Dimensions (W × H × D) in mm	18 × 90 × 53	36 × 90 × 53	54 × 90 × 53	72 × 90 × 53
Weight	0.07 kg	0.12 kg	0.2 kg	0.29 kg

## Mounting/removal

### **! WARNING**

#### **Installing the device in a housing or a control cabinet**

LOGO!Power power supplies are built-in devices. They must be installed in a casing or control cabinet to which only qualified personnel have access.

The devices can be mounted in a control cabinet on standard mounting rails according to (see Mechanical system (Page 72)). All devices are suitable for mounting directly on walls.

#### **Mounting**

To mount the device on a standard mounting, position it with the mounting rail guide at the upper edge of the standard mounting rail and press down to lock it into place. If this is too difficult, press slider ① at the same time, as described for "Disassembly".

#### **Disassembly**

To remove, pull up the slider ① using a screwdriver ② and disengage the device at the bottom edge of the DIN rail. Then you can remove the device from the upper edge of the DIN rail.

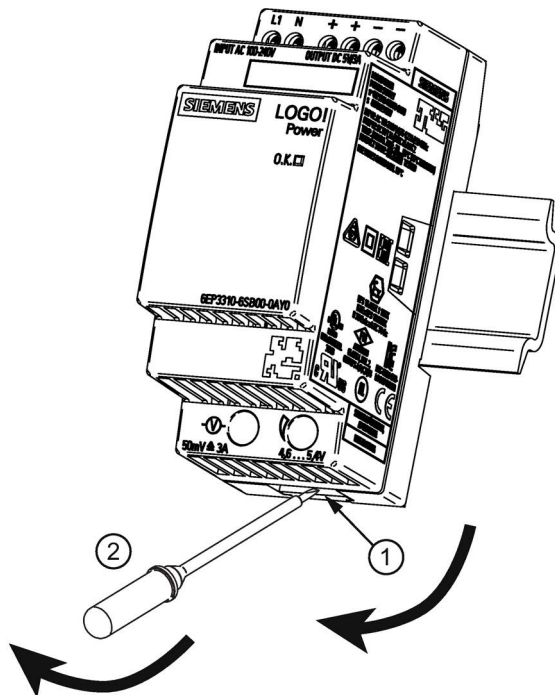

Figure 3-1 Mounting/removal (example 6EP3310-6SB00-0AY0)

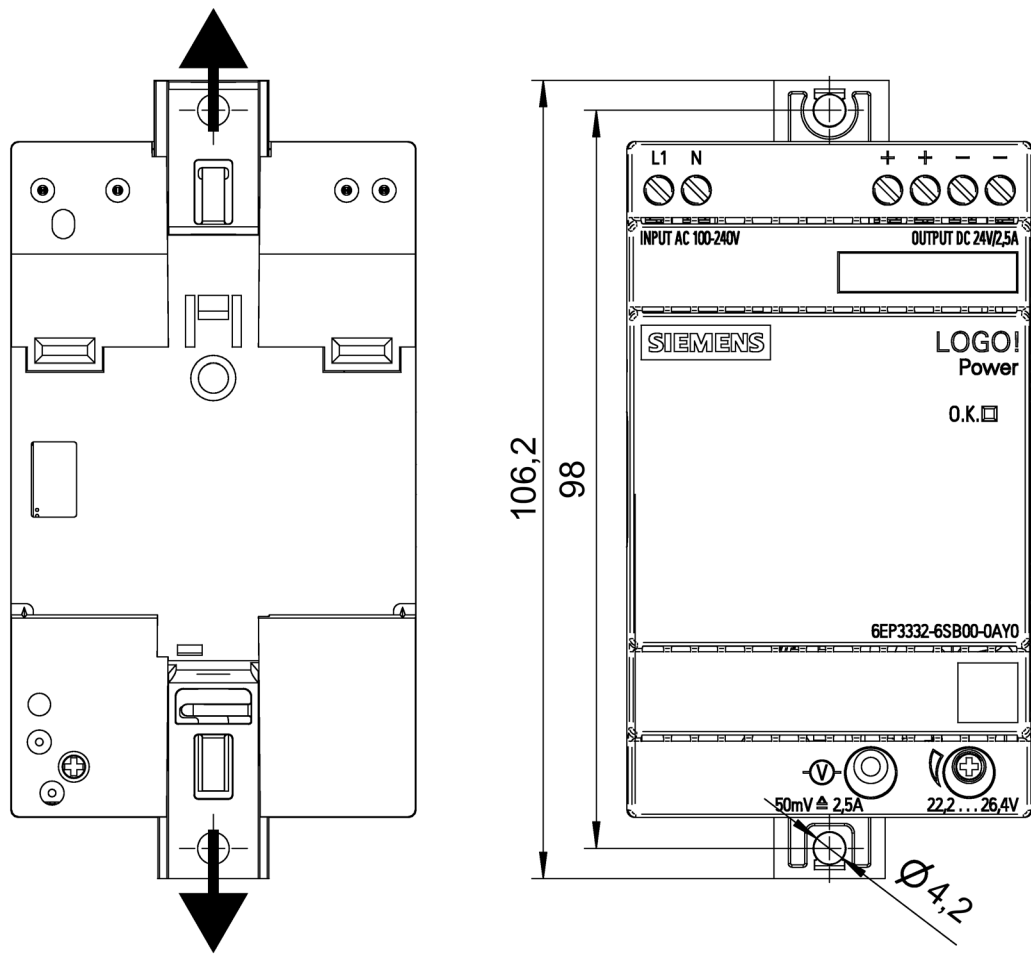

Figure 3-2 Wall mounting

To mount on a flat surface, place the device with the sliders ① extended over the holes as shown in Fig. 3-2, and fix in place using suitable screws.

**⚠ WARNING**

**Use in hazardous zones**

If the device is to be used in a hazardous zone (Ex II 3G Ex nA IIC T3) it must be installed in a distributor box with degree of protection IP54 or higher.

## Mounting position, mounting clearances

### 4.1 Standard mounting position

The device is mounted on standard mounting rails according to EN 60715 35x7,5/15. To ensure correct cooling, the device should be vertically mounted so that the terminal strip or, as a result of the different designs, the output terminal of the 18 mm wide devices is at the top.

A clearance of at least 20 mm should be maintained above and below the device.

No space is required at the side.

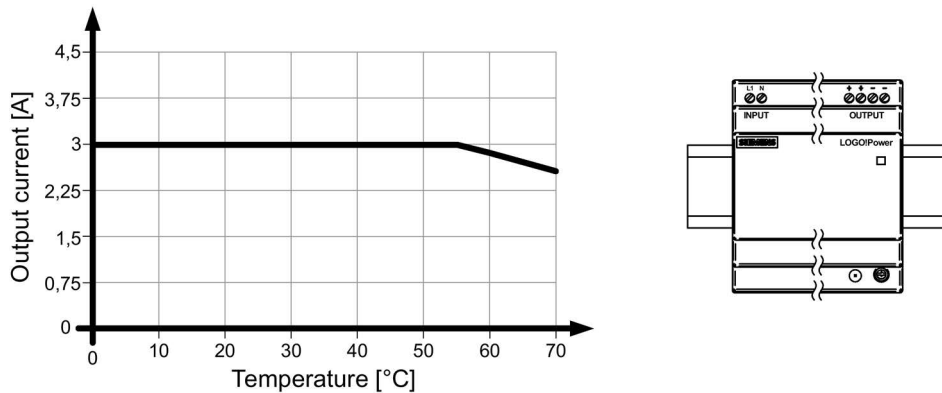

Figure 4-1 Output current for the standard mounting position 6EP3310-6SB00-0AY0

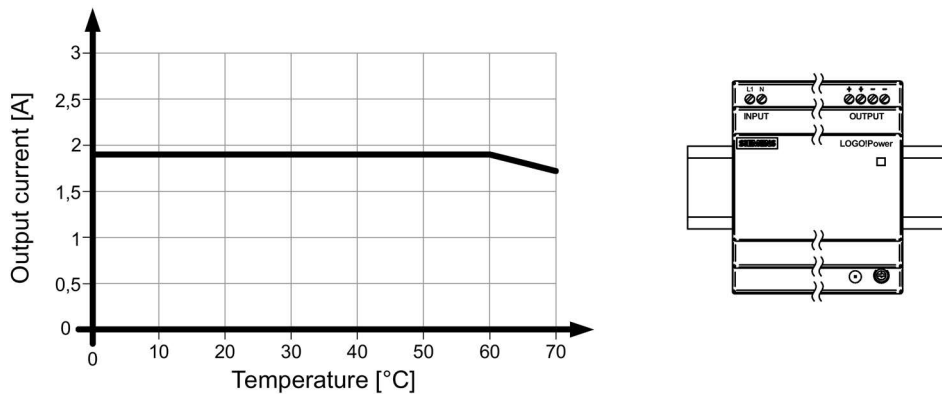

Figure 4-2 Output current for the standard mounting position 6EP3321-6SB00-0AY0

4.1 Standard mounting position

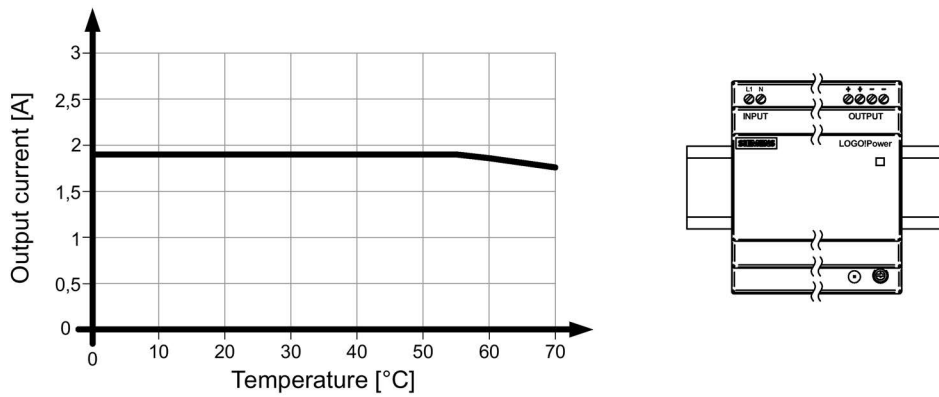

Figure 4-3 Output current for the standard mounting position 6EP3321-6SB10-0AY0

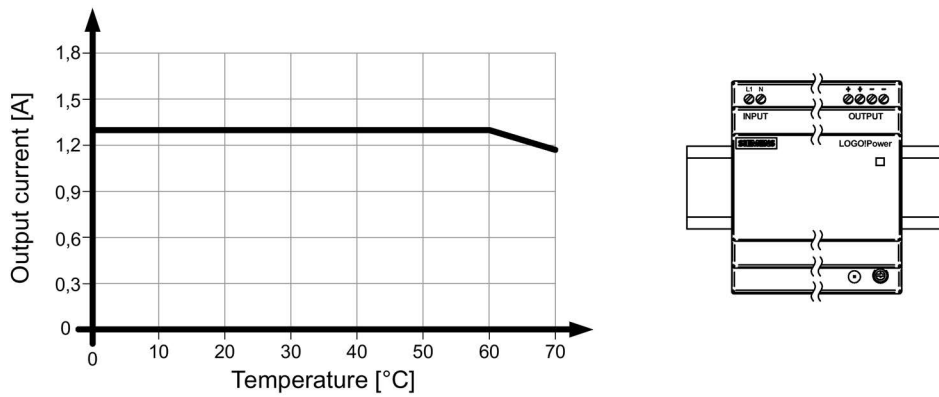

Figure 4-4 Output current for the standard mounting position 6EP3331-6SB00-0AY0

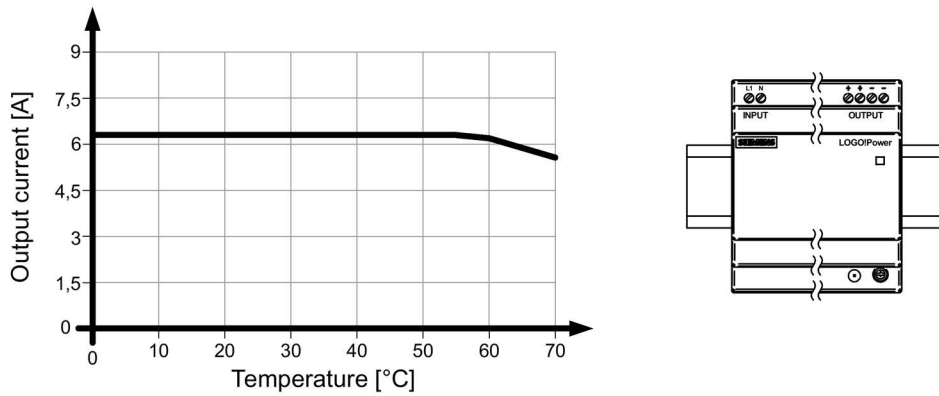

Figure 4-5 Output current for the standard mounting position 6EP3311-6SB00-0AY0



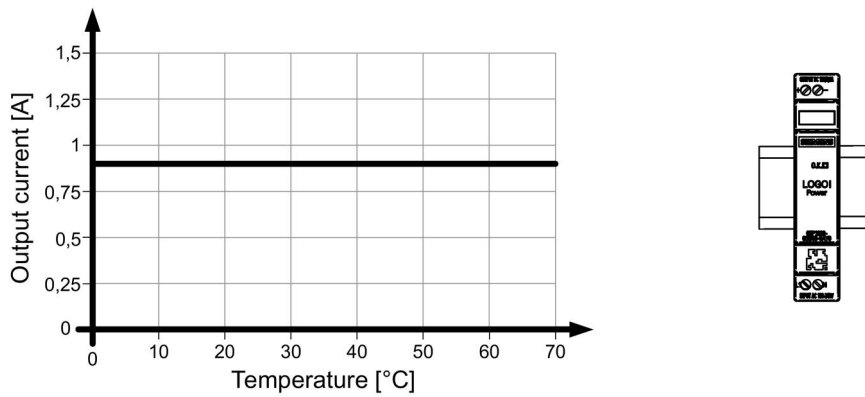

Figure 4-6 Output current for the standard mounting position 6EP3320-6SB00-0AY0

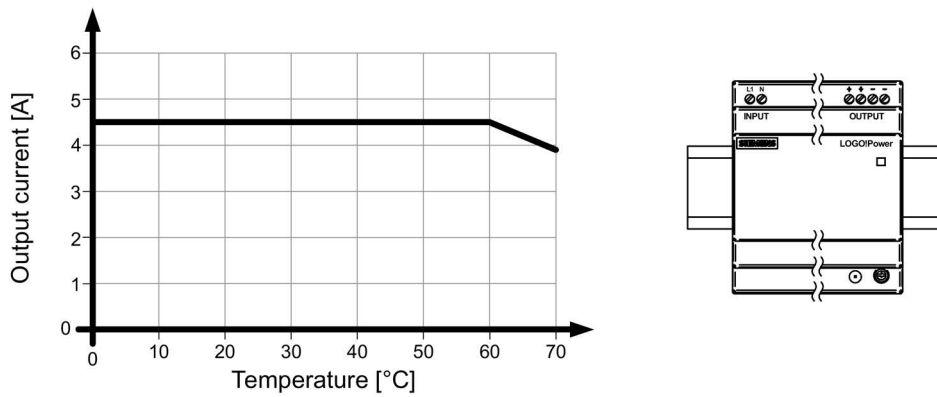

Figure 4-7 Output current for the standard mounting position 6EP3322-6SB00-0AY0

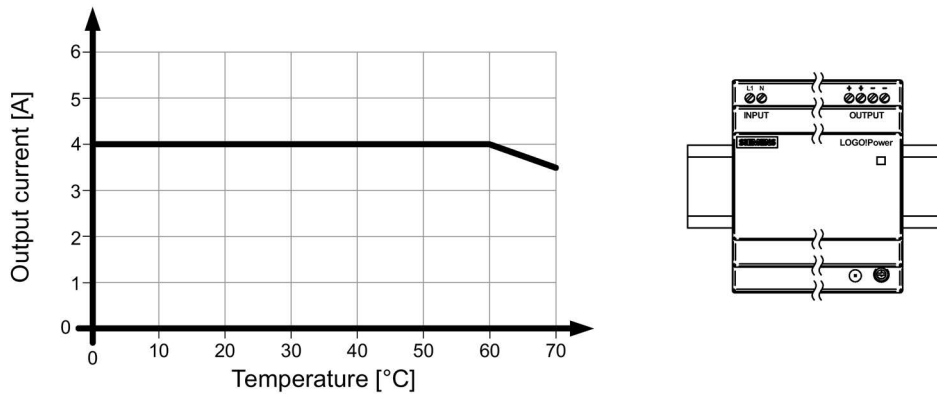

Figure 4-8 Output current for the standard mounting position 6EP3322-6SB10-0AY0

4.1 Standard mounting position

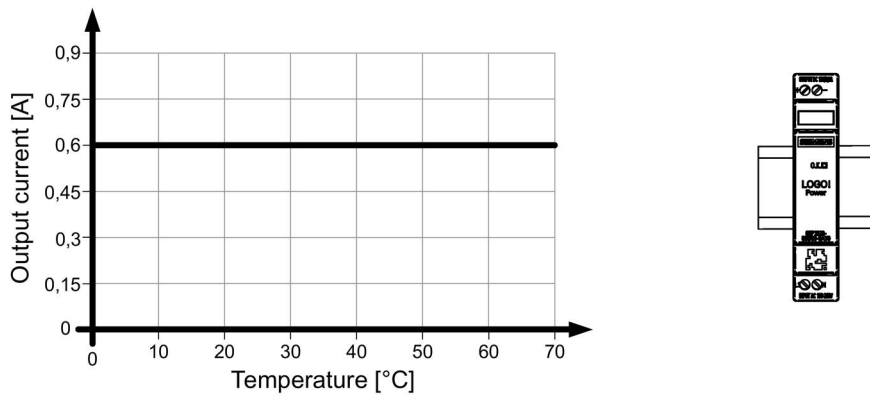

Figure 4-9 Output current for the standard mounting position 6EP3330-6SB00-0AY0

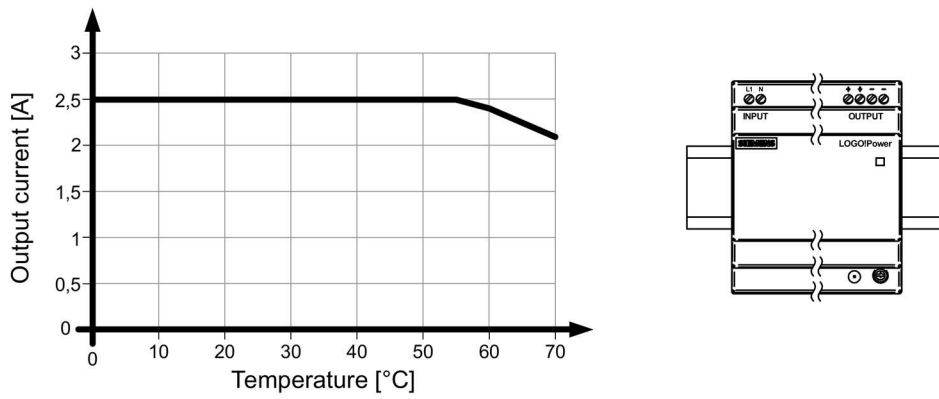

Figure 4-10 Output current for the standard mounting position 6EP3332-6SB00-0AY0

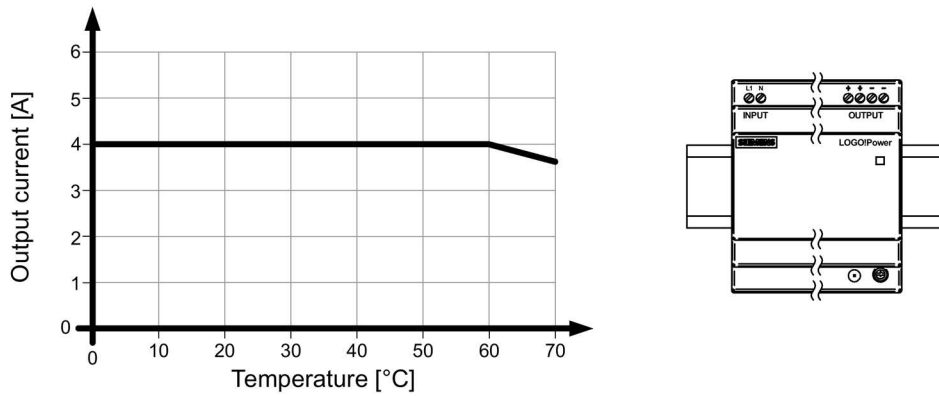

Figure 4-11 Output current for the standard mounting position 6EP3333-6SB00-0AY0

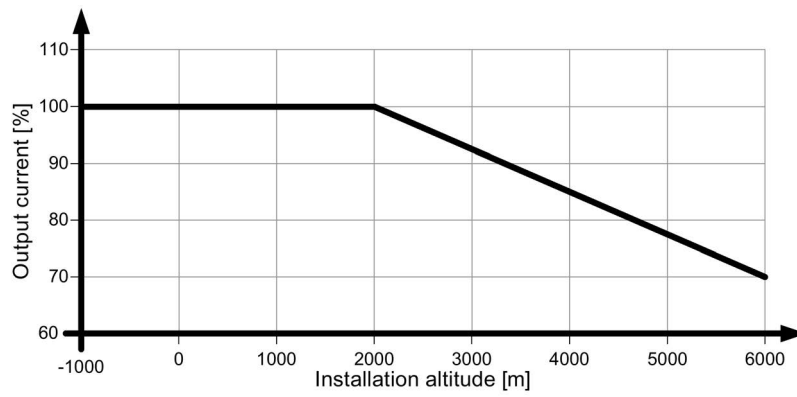

Figure 4-12 Mounting height derating

For details, see Section Ambient conditions (Page 79)

## 4.2 Other mounting positions

For mounting positions that deviate from the standard mounting position, derating factors (reduction of the output power or the permissible ambient temperature) must be observed in accordance with the following diagrams.

### Note

In the case of mounting positions that deviate from the standard mounting position, reduced mechanical resistance of the devices against vibration and shock must be expected.

Particularly when installing on a vertically fastened standard mounting rail, additional measures may be required, e.g. to prevent the device from slipping on the standard mounting rail.

### 4.2.1 6EP3310-6SB00-0AY0 (5V 3A)

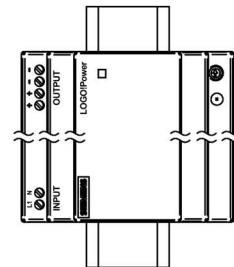
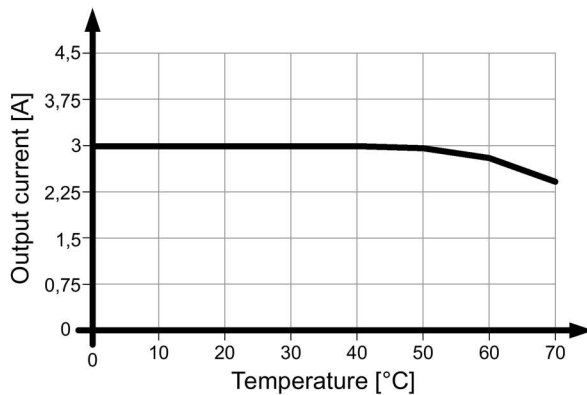

Figure 4-13 Mounting position 1

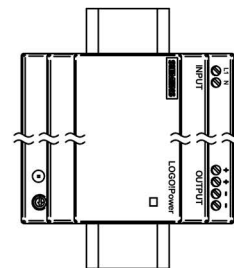
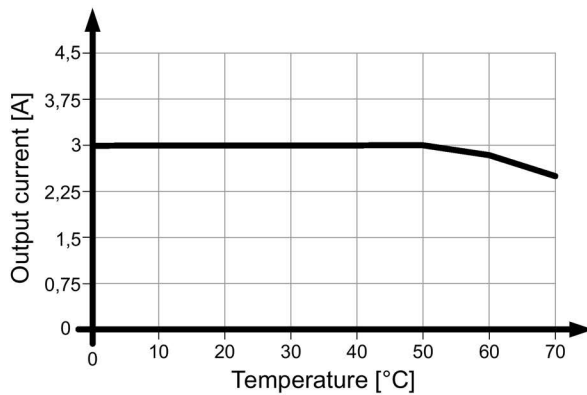

Figure 4-14 Mounting position 2

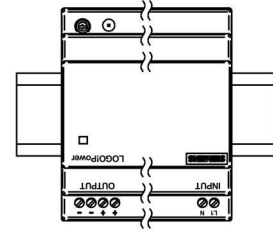
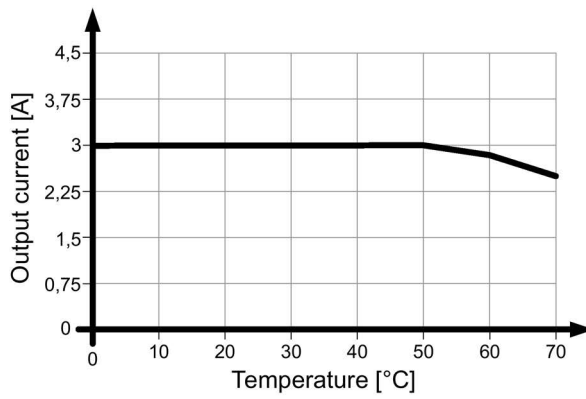

Figure 4-15 Mounting position 3

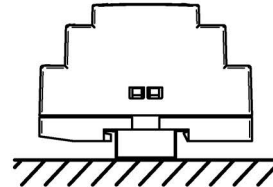
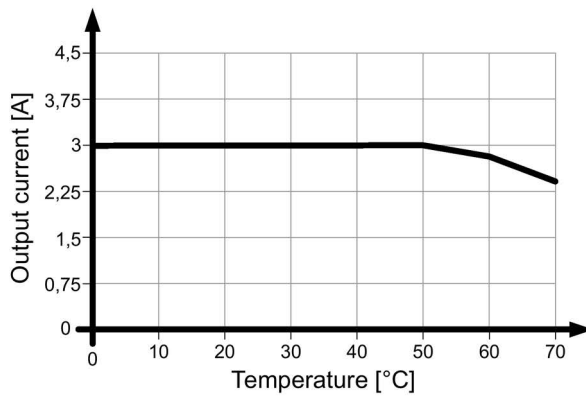

Figure 4-16 Mounting position 4

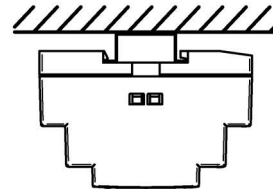
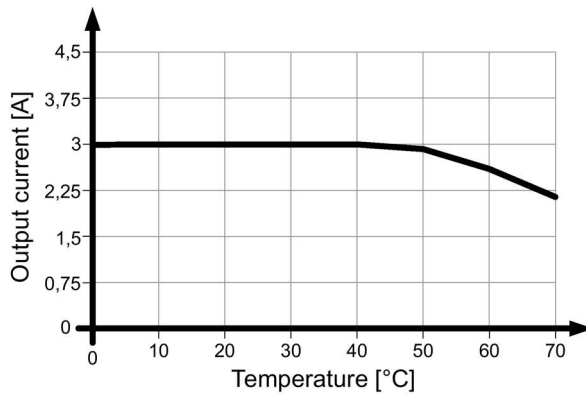

Figure 4-17 Mounting position 5

4.2 Other mounting positions

4.2.2 6EP3311-6SB00-0AY0 (5V 6.3A)

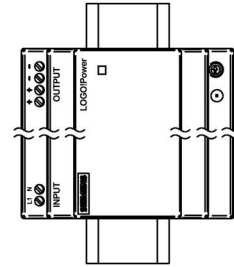
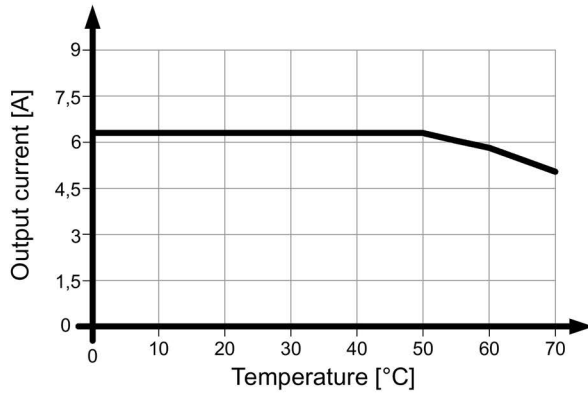

Figure 4-18 Mounting position 1

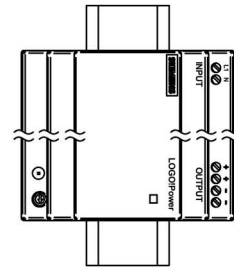
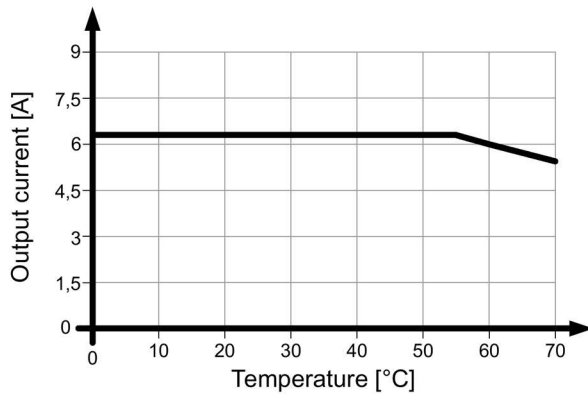

Figure 4-19 Mounting position 2

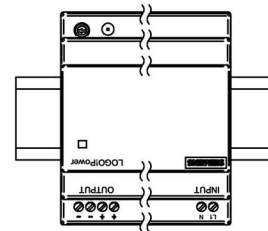
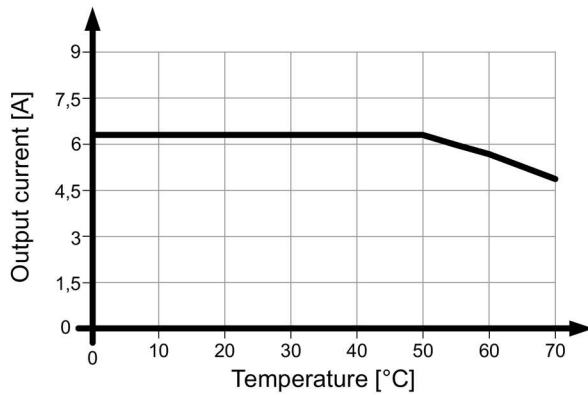

Figure 4-20 Mounting position 3

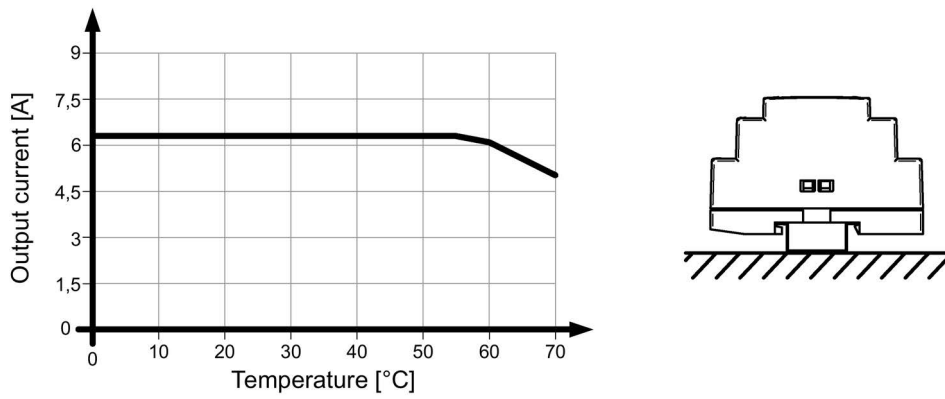

Figure 4-21 Mounting position 4

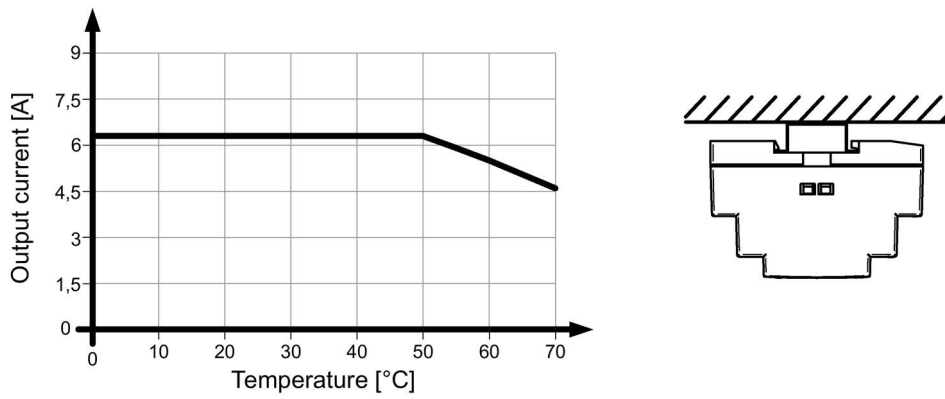

Figure 4-22 Mounting position 5

4.2.3 6EP3320-6SB00-0AY0 (12V 0.9A)

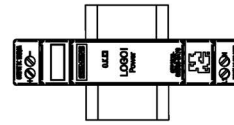
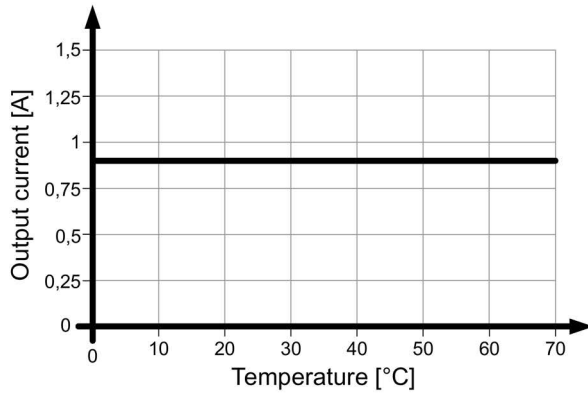

Figure 4-23 Mounting position 1

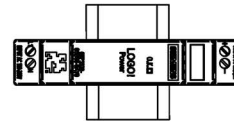
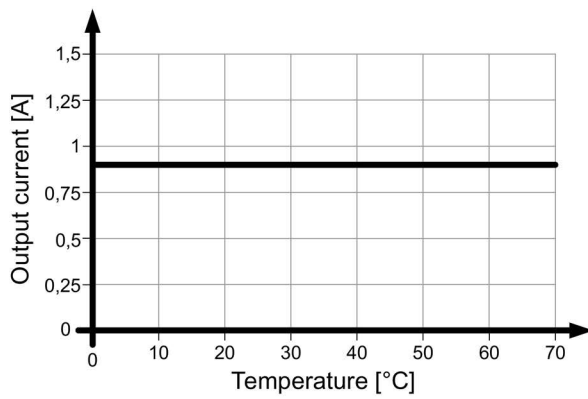

Figure 4-24 Mounting position 2

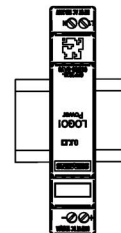
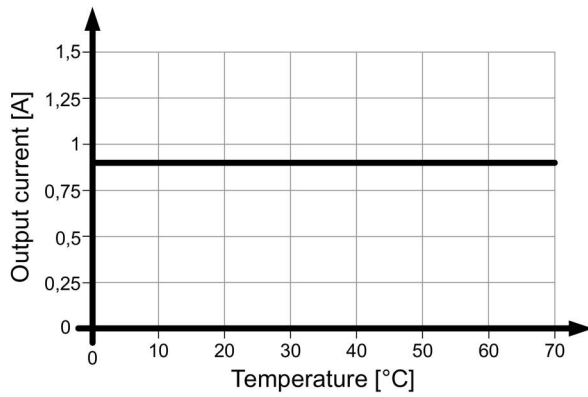

Figure 4-25 Mounting position 3



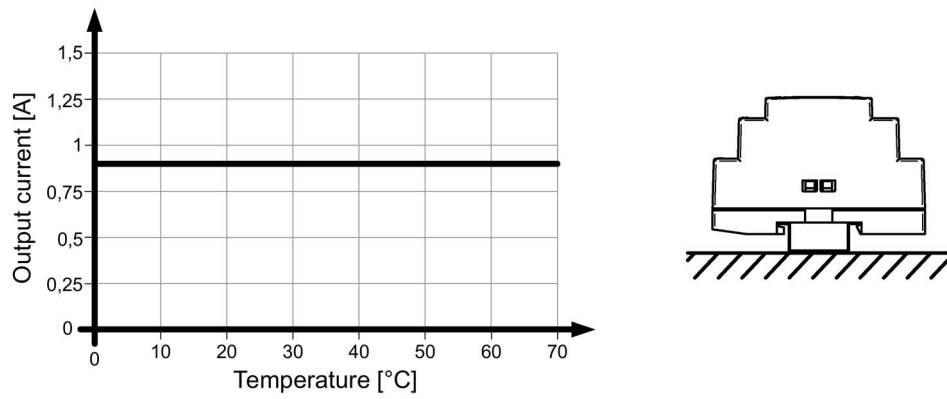

Figure 4-26 Mounting position 4

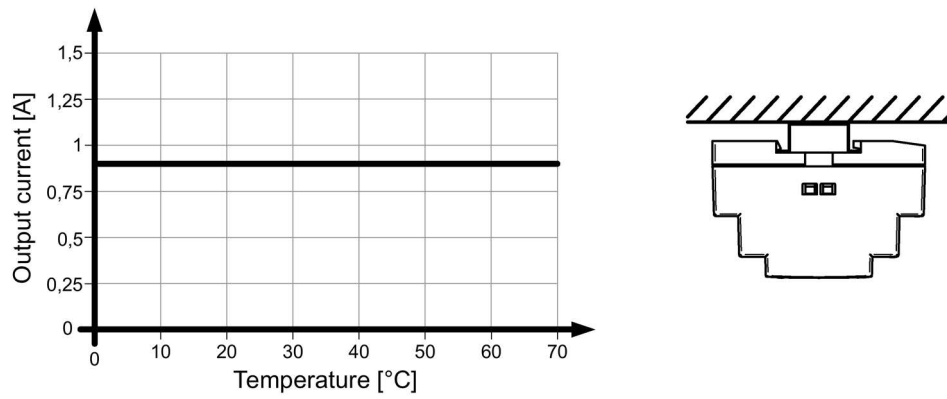

Figure 4-27 Mounting position 5

4.2.4 6EP3321-6SB00-0AY0 (12V 1.9A)

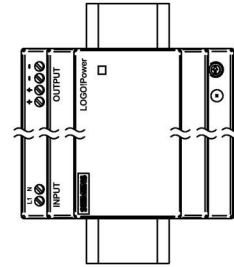
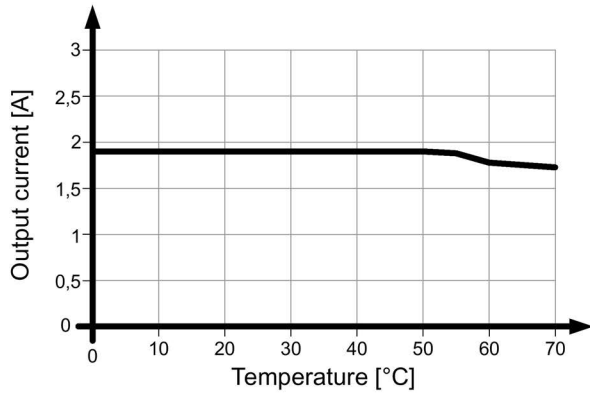

Figure 4-28 Mounting position 1

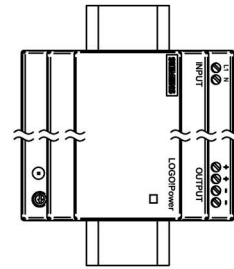
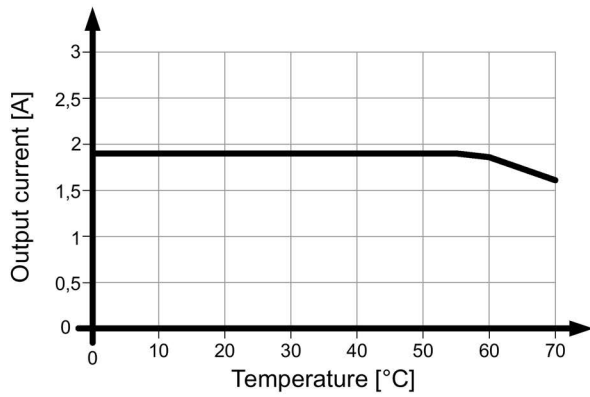

Figure 4-29 Mounting position 2

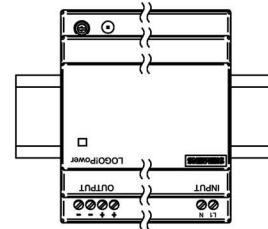
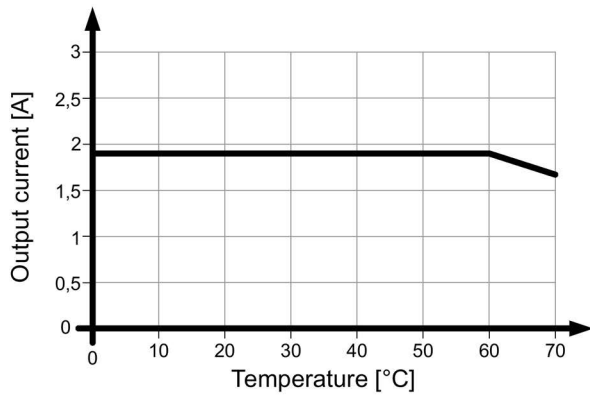

Figure 4-30 Mounting position 3

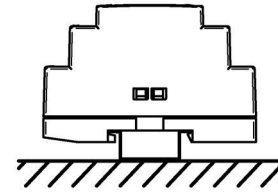
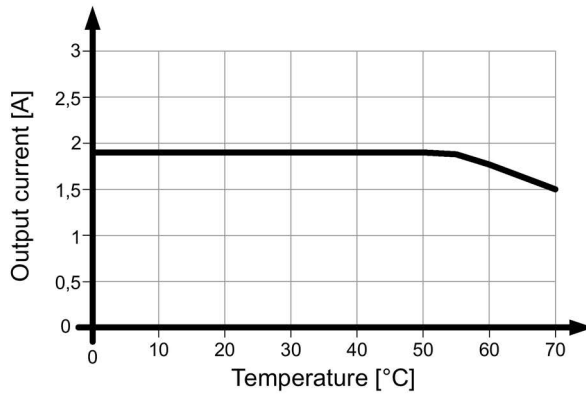

Figure 4-31 Mounting position 4

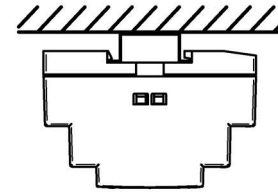
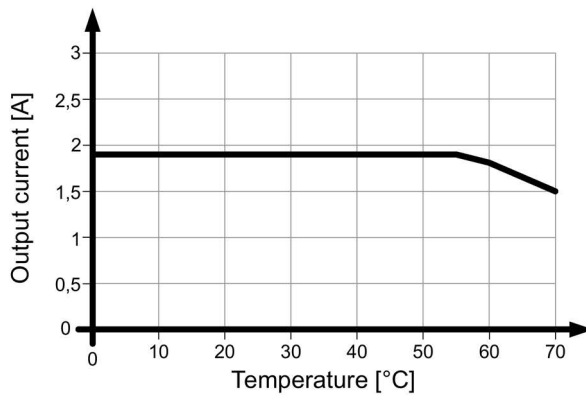

Figure 4-32 Mounting position 5

4.2.5 6EP3322-6SB00-0AY0 (12V 4.5A)

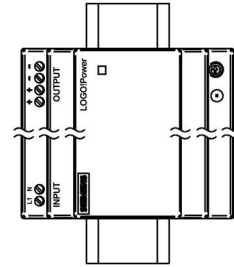
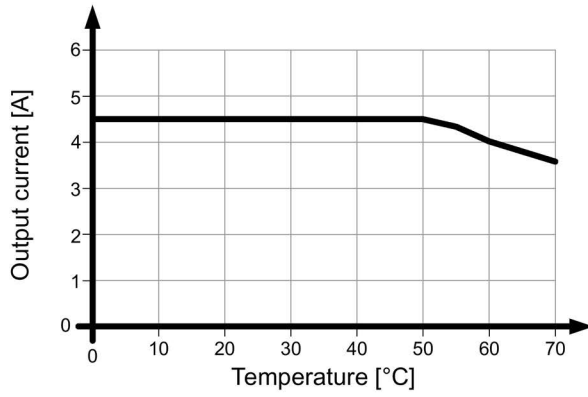

Figure 4-33 Mounting position 1

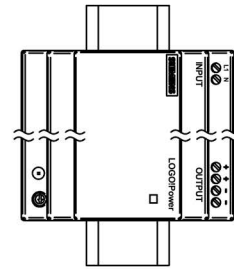
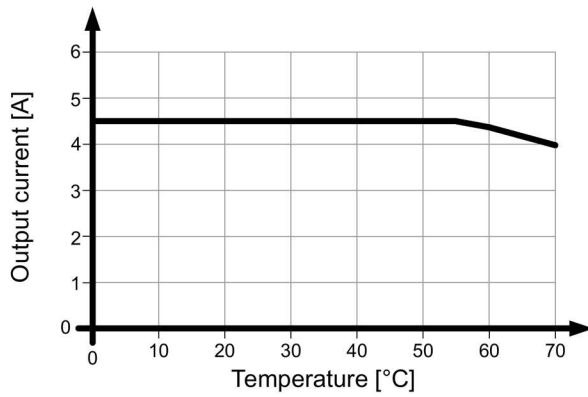

Figure 4-34 Mounting position 2

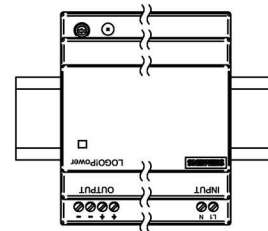
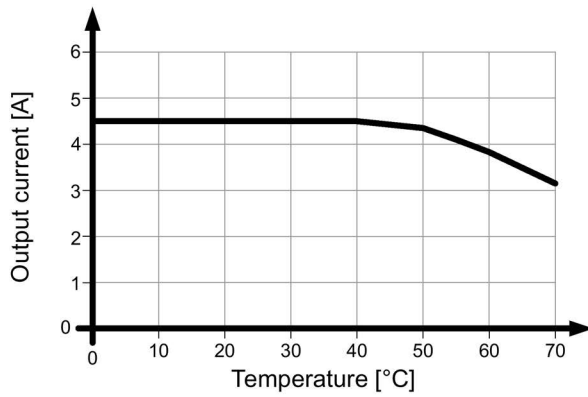

Figure 4-35 Mounting position 3

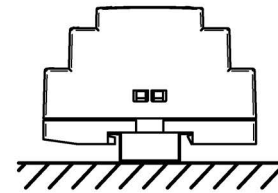
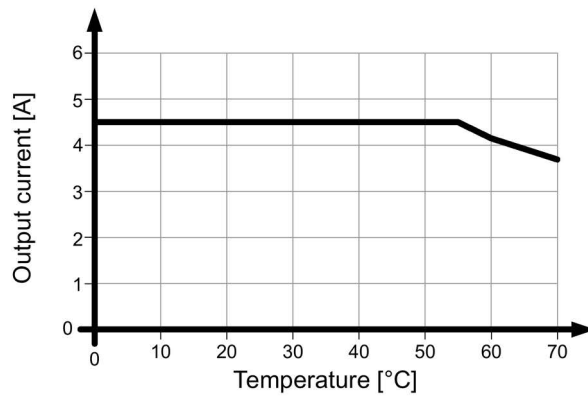

Figure 4-36 Mounting position 4

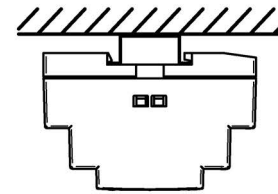
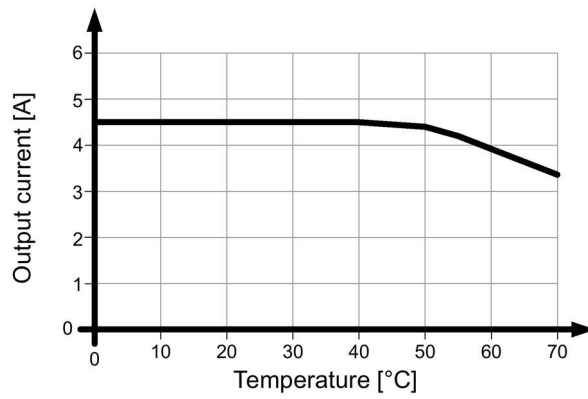

Figure 4-37 Mounting position 5

4.2.6 6EP3321-6SB10-0AY0 (15V 1.9A)

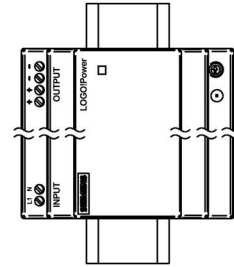
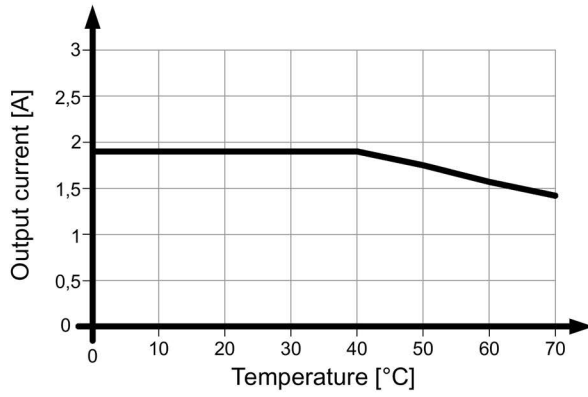

Figure 4-38 Mounting position 1

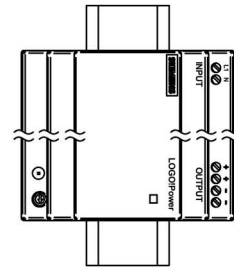
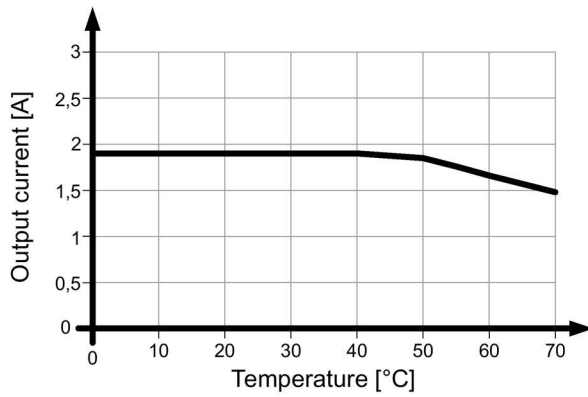

Figure 4-39 Mounting position 2

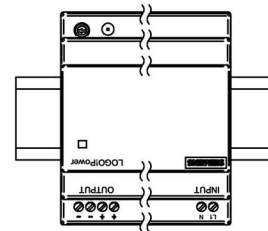
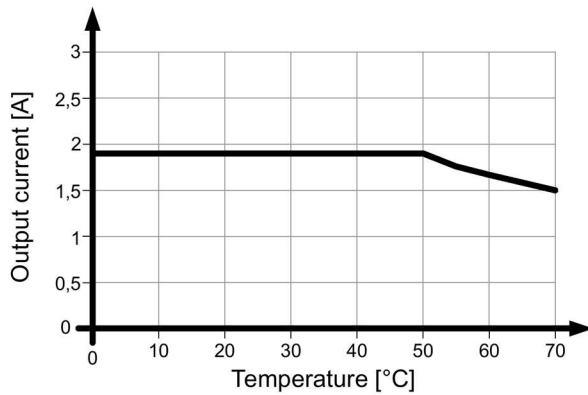

Figure 4-40 Mounting position 3

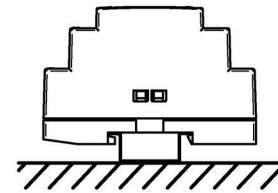
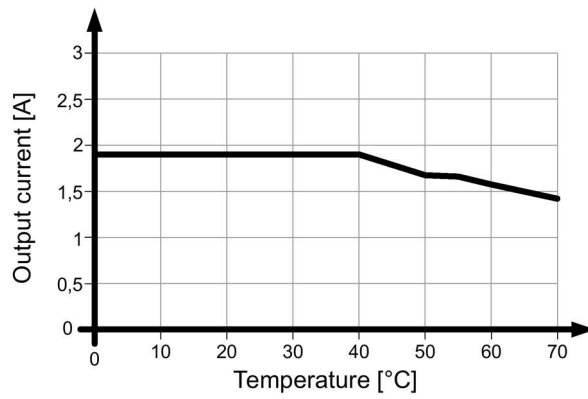

Figure 4-41 Mounting position 4

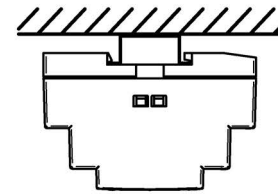
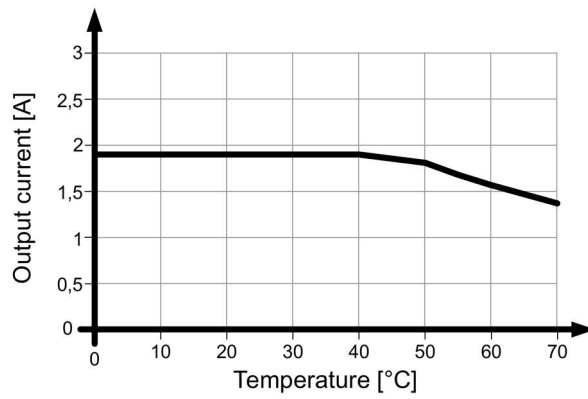

Figure 4-42 Mounting position 5

4.2.7 6EP3322-6SB10-0AY0 (15V 4A)

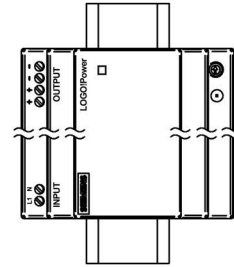
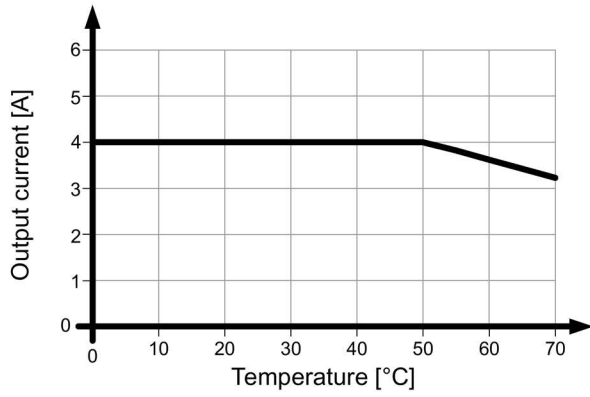

Figure 4-43 Mounting position 1

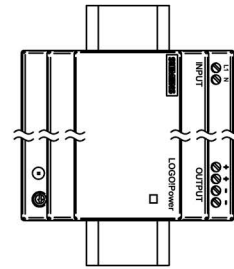
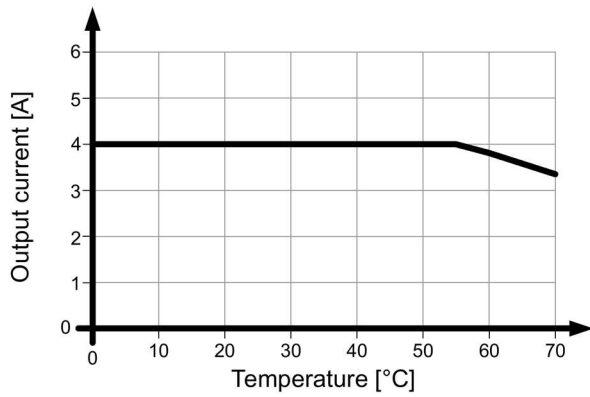

Figure 4-44 Mounting position 2

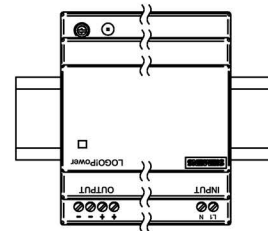
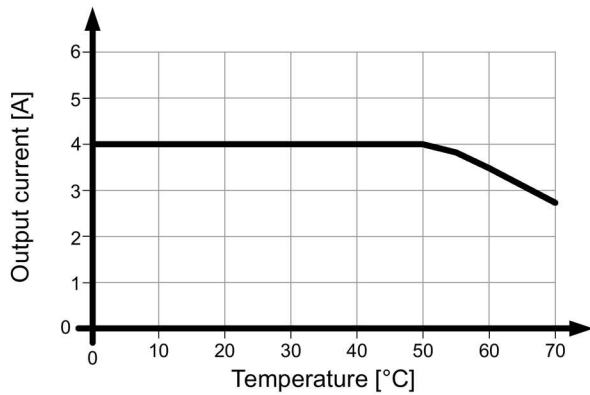

Figure 4-45 Mounting position 3



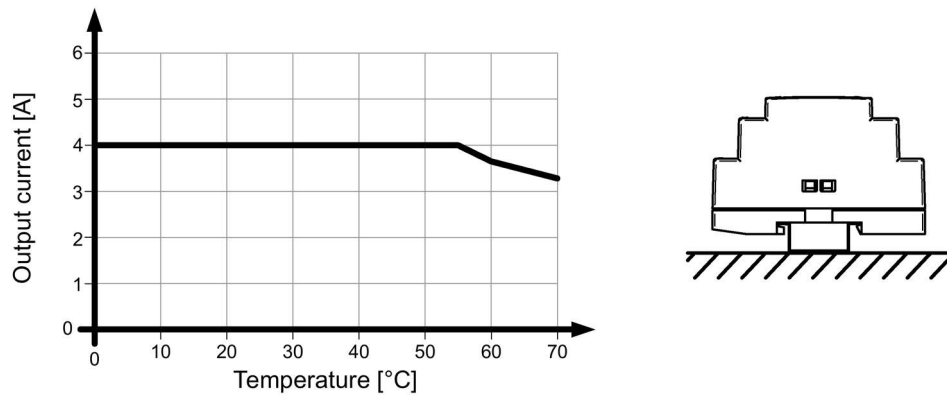

Figure 4-46 Mounting position 4

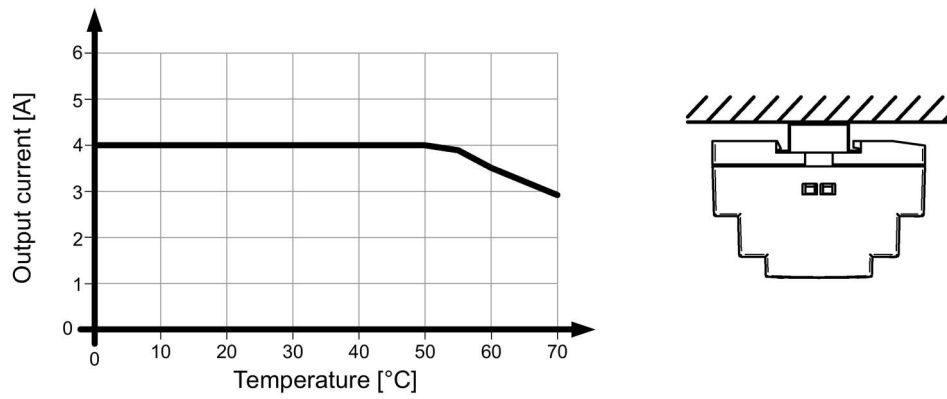

Figure 4-47 Mounting position 5

### 4.2.8 6EP3330-6SB00-0AY0 (24V 0.6A)

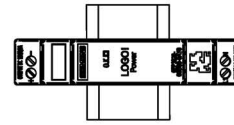
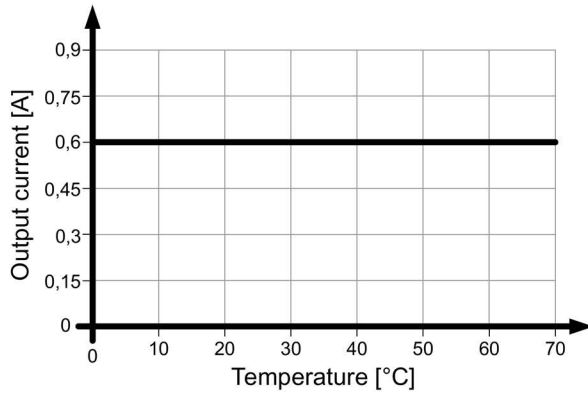

Figure 4-48 Mounting position 1

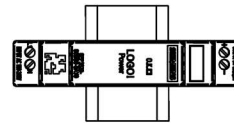
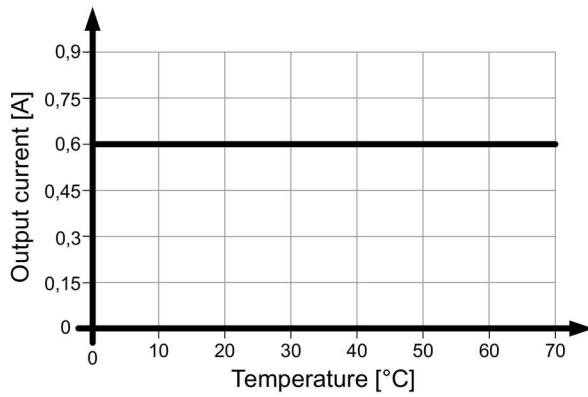

Figure 4-49 Mounting position 2

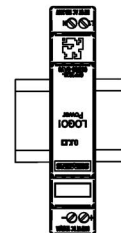
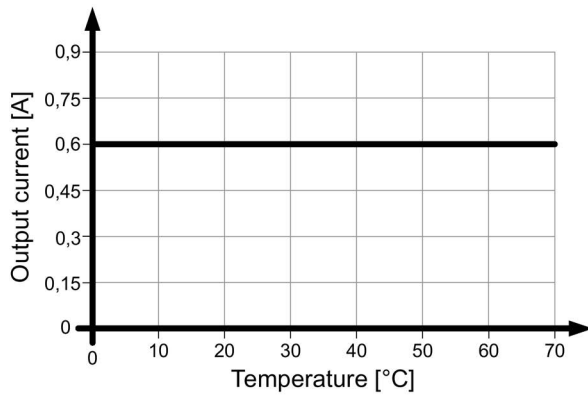

Figure 4-50 Mounting position 3

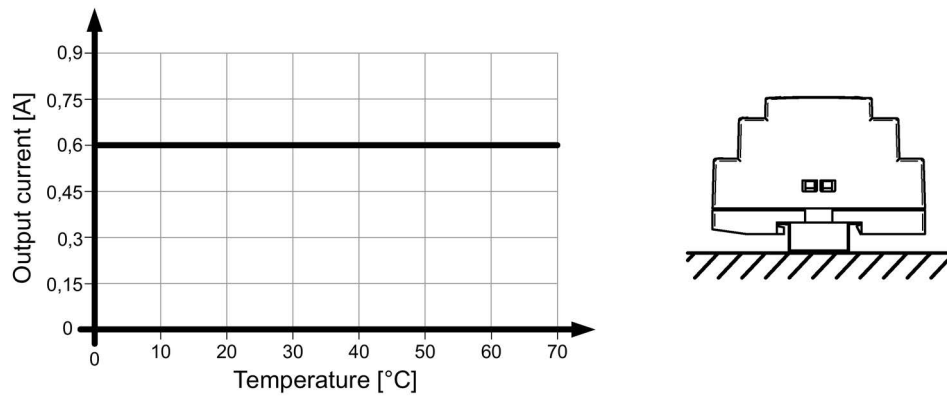

Figure 4-51 Mounting position 4

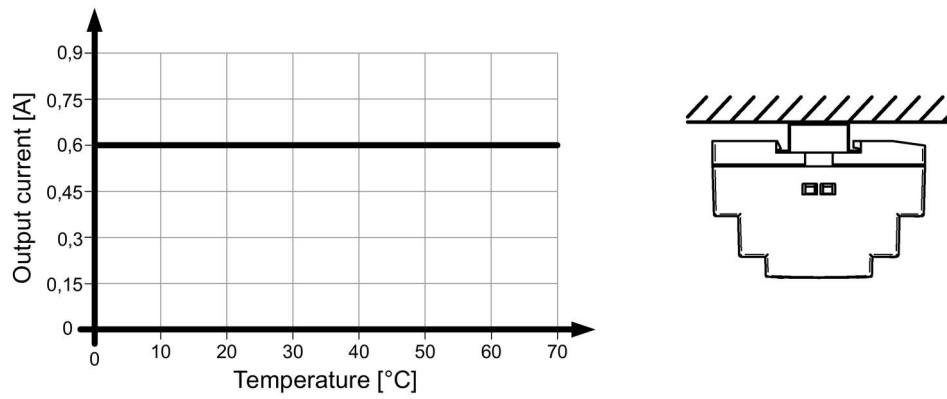

Figure 4-52 Mounting position 5

4.2.9 6EP3331-6SB00-0AY0 (24V 1.3A)

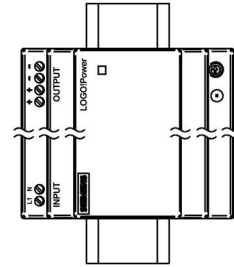
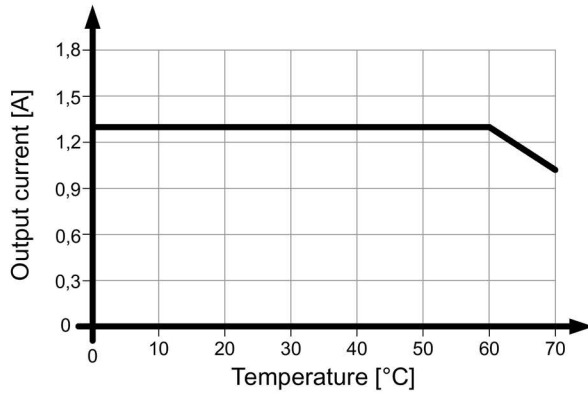

Figure 4-53 Mounting position 1

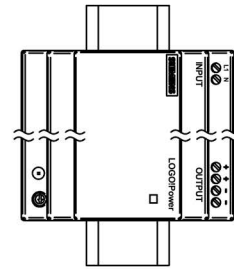
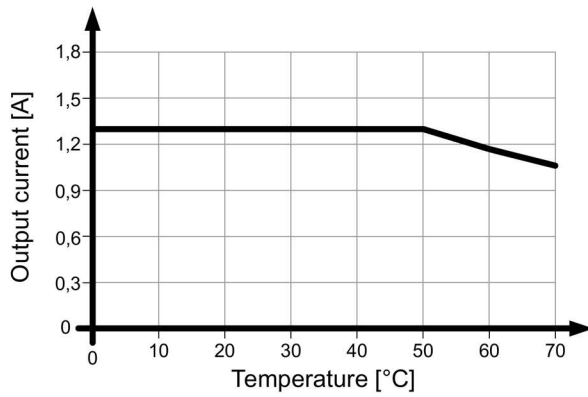

Figure 4-54 Mounting position 2

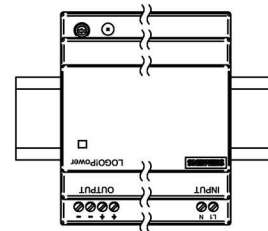
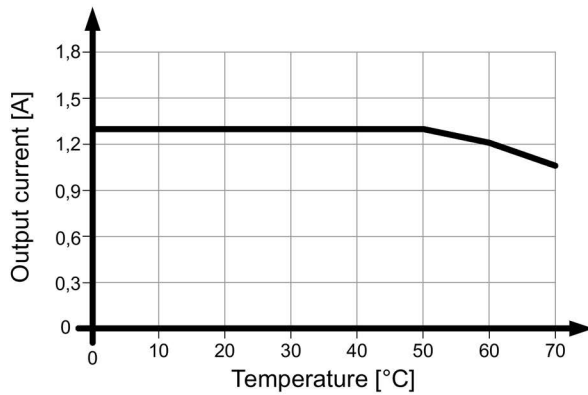

Figure 4-55 Mounting position 3

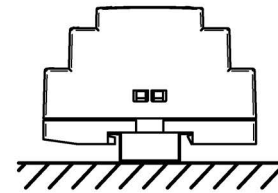
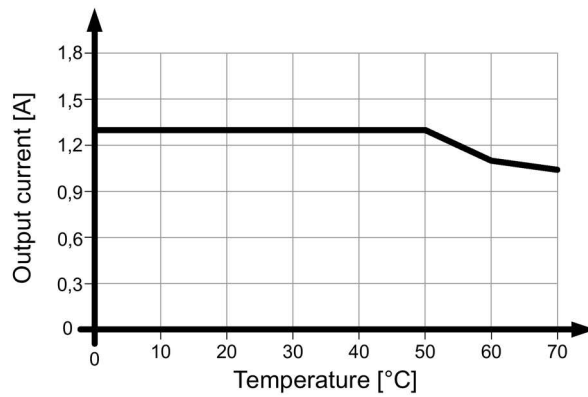

Figure 4-56 Mounting position 4

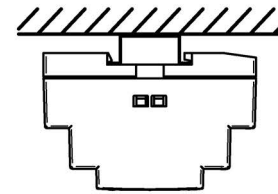
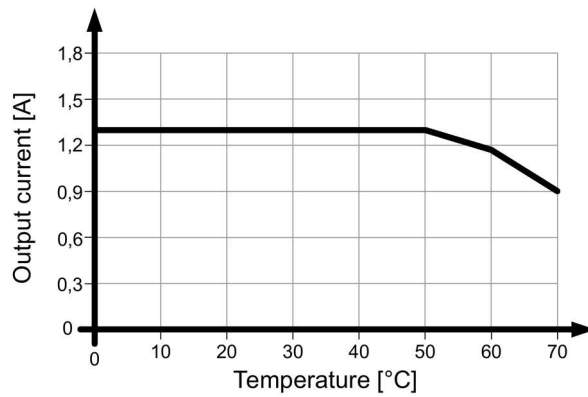

Figure 4-57 Mounting position 5

4.2.10 6EP3332-6SB10-0AY0 (24V 2.5A)

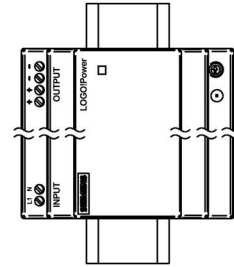
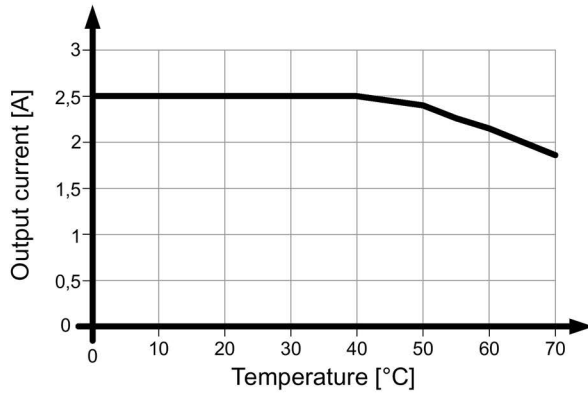

Figure 4-58 Mounting position 1

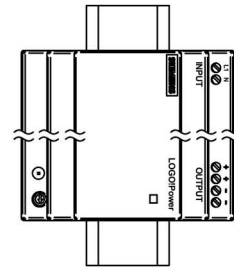
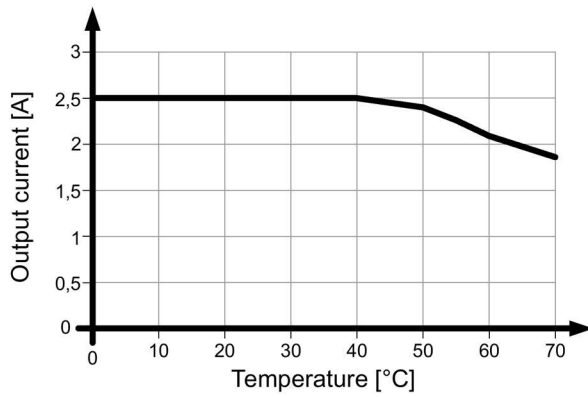

Figure 4-59 Mounting position 2

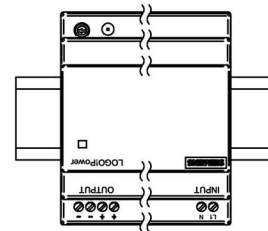
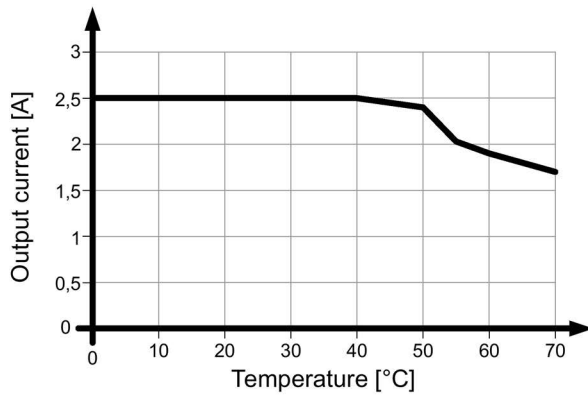

Figure 4-60 Mounting position 3

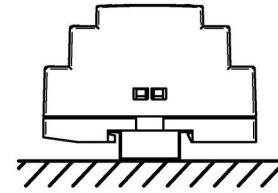
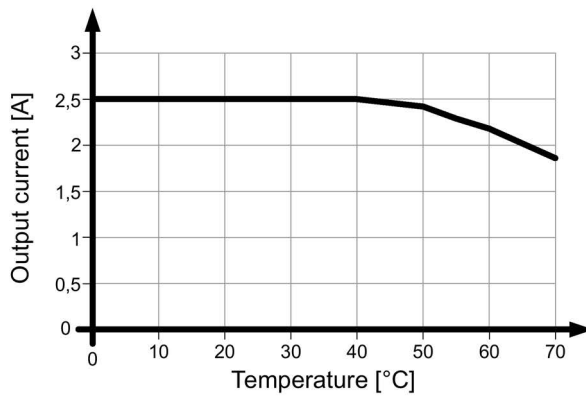

Figure 4-61 Mounting position 4

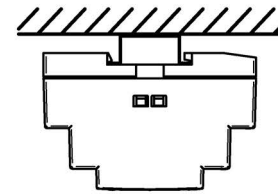
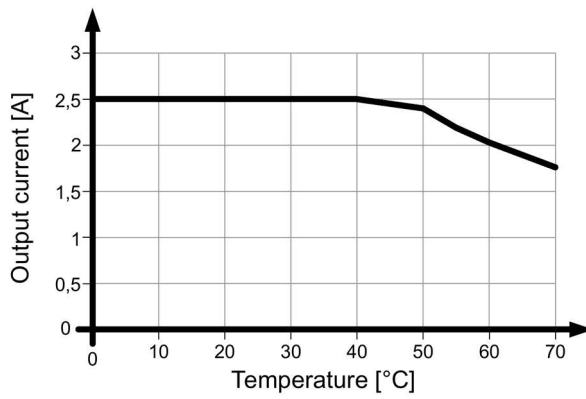

Figure 4-62 Mounting position 5

4.2.11 6EP3333-6SB00-0AY0 (24V 4A)

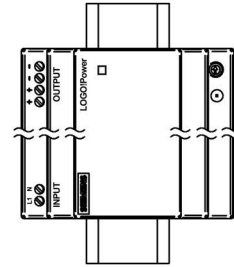
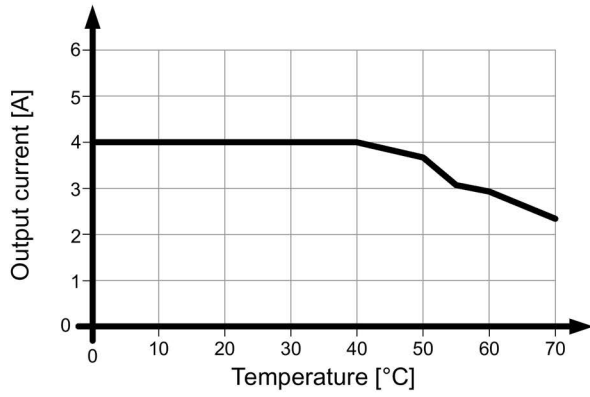

Figure 4-63 Mounting position 1

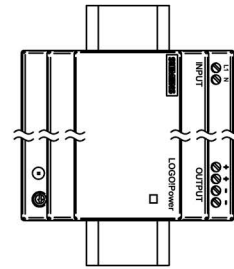
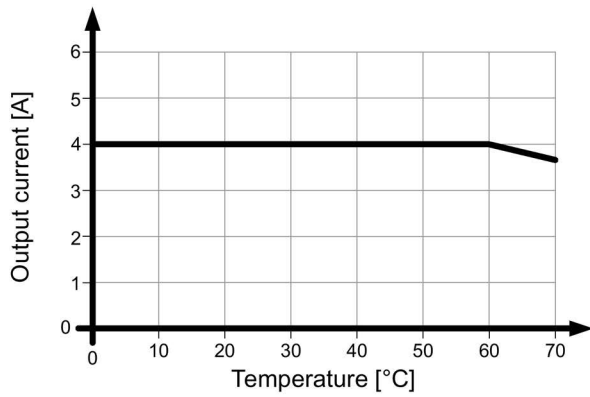

Figure 4-64 Mounting position 2

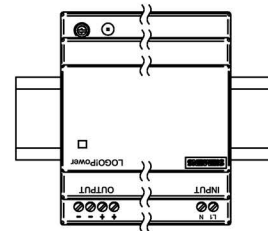
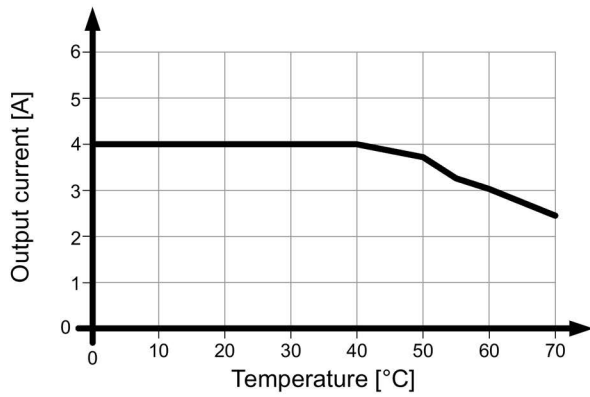

Figure 4-65 Mounting position 3



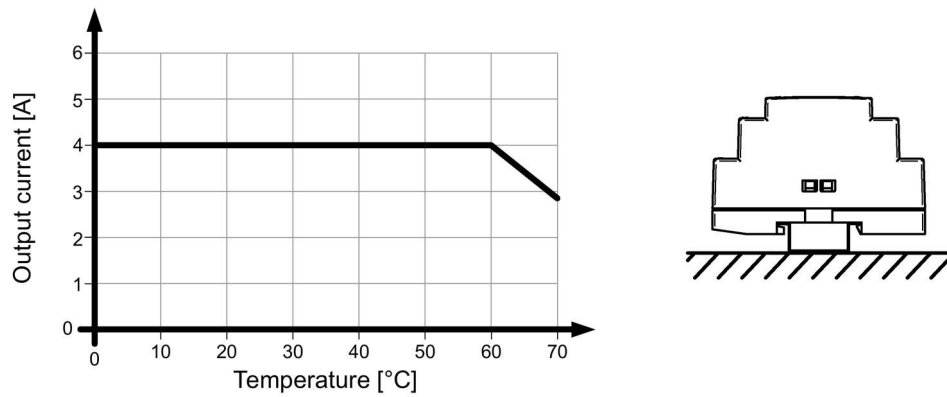

Figure 4-66 Mounting position 4

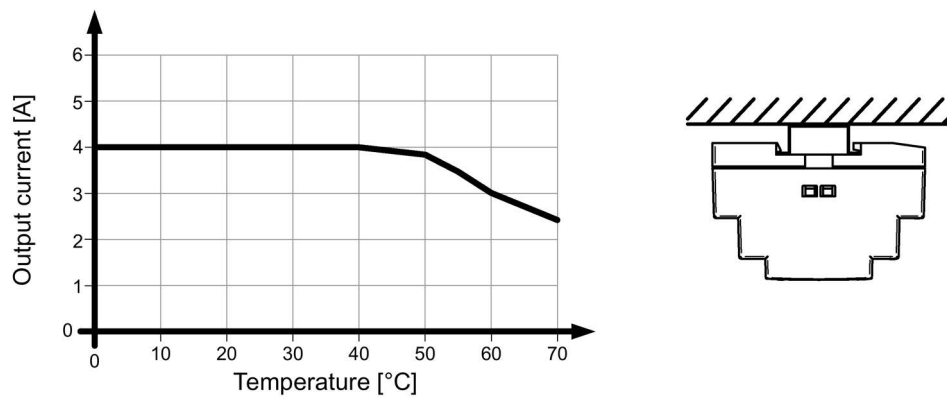

Figure 4-67 Mounting position 5

*4.2 Other mounting positions*

<p><b>⚠ WARNING</b></p> <p><b>Hazard due to electric shock</b></p> <p>Before installation or maintenance work can begin, the system's main switch must be switched off and measures taken to prevent it being switched on again. If this instruction is not observed, touching live parts can result in death or serious injury.</p>
--

## 5.1 Line-side connection

LOGO!Power power supplies are devices that are connected to a line supply with protection class II (without protective conductor, which means without PE). LOGO!Power are designed for connection to 1-phase AC line supplies (TN or TT line supply according to IEC 60364-1) with rated voltage 1 AC 100 - 240 V, 50/60 Hz or to a DC power supply with 110 - 300 V DC.

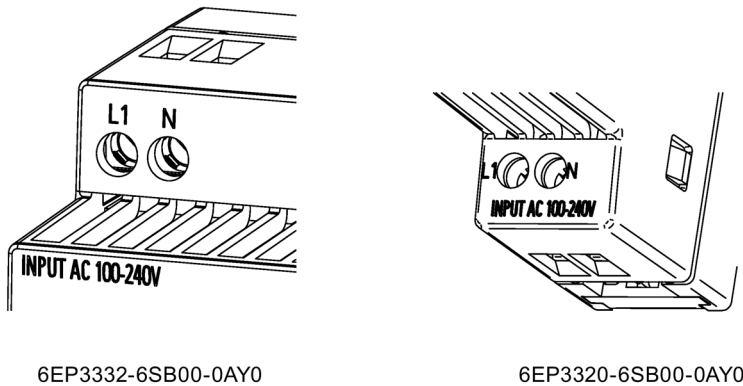

Figure 5-1 Line connection (example)

The line supply is connected using terminal L1 and N (see Figure Line connection (example) (Page 51)), and must be implemented according to IEC 60364 and EN 50178. A protective device (miniature circuit-breaker or circuit-breaker) and a disconnection unit for the power supply must be provided. A ground-fault circuit interrupter must not be used as the only protective measure against indirect contact; this applies to the entire supply system that is protected by the residual current operated circuit-breaker.

---

### Note

For operation on a direct voltage network (DC), the plus pole (+) must be connected to L1 and the minus pole (-) to N.

---

**Protection**

<b>LOGO!Power</b>	<b>Recommended line-side protection</b>
6EP3310-6SB00-0AY0 (5 V/3 A)	Recommended miniature circuit breaker, characteristic B (C) 6 A (2 A)
6EP3311-6SB00-0AY0 (5 V/6.3 A)	Recommended miniature circuit breaker, characteristic B (C) 10 A (6 A)
6EP3320-6SB00-0AY0 (12 V/0.9 A)	Recommended miniature circuit breaker, characteristic B (C) 6 A (2 A)
6EP3321-6SB00-0AY0 (12 V/1.9 A)	Recommended miniature circuit breaker, characteristic B (C) 6 A (2 A)
6EP3322-6SB00-0AY0 (12 V/4.5 A)	Recommended miniature circuit breaker, characteristic B (C) 10 A (6 A)
6EP3321-6SB10-0AY0 (15 V/1.9 A)	Recommended miniature circuit breaker, characteristic B (C) 6 A (2 A)
6EP3322-6SB10-0AY0 (15 V/4 A)	Recommended miniature circuit breaker, characteristic B (C) 10 A (6 A)
6EP3330-6SB00-0AY0 (24 V/0.6 A)	Recommended miniature circuit breaker, characteristic B (C) 6 A (2 A)
6EP3331-6SB00-0AY0 (24 V/1.3 A)	Recommended miniature circuit breaker, characteristic B (C) 6 A (2 A)
6EP3332-6SB00-0AY0 (24 V/2.5 A)	Recommended miniature circuit breaker, characteristic B (C) 10 A (6 A)
6EP3333-6SB00-0AY0 (24 V/4 A)	Recommended miniature circuit breaker, characteristic B (C) 10 A (6 A)

**NOTICE**

Country-specific regulations must be observed when installing.

## 5.2 Output-side connection

LOGO!Power power supplies provide an isolated (= non-grounded, floating) SELV (Safety Extra Low Voltage) output voltage. The output of the power supplies is no-load, overload and short-circuit proof. If an overload occurs, the electronic current limiting function limits the output current to a maximum value (see Section Technical data (Page 55)).

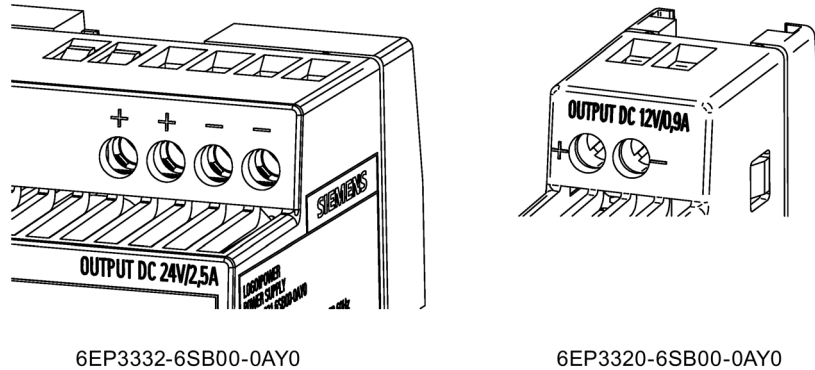

Figure 5-2 Output (examples)

The output voltage is connected via the + and - terminals at the output of the power supply (see Figure Output (examples) (Page 53)). Make sure that the output cables are dimensioned correctly for the maximum output current rms value and fused accordingly.

---

### Note

When using LOGO!Power in conjunction with devices of the protection class I (with protective conductor), a connection must be established between "-" and "PE" with at least 1.5 mm<sup>2</sup>.

---



## Technical data

### Note

Technical data apply for a rated input voltage, rated load and 25 °C ambient temperature if nothing else is specified.

### 6.1 Input

	<b>6EP3310-6SB00-0AY0 (5 V/3 A)</b>	<b>6EP3311-6SB00-0AY0 (5 V/6.3 A)</b>	<b>6EP3320-6SB00-0AY0 (12 V/0.9 A)</b>	<b>6EP3321-6SB00-0AY0 (12 V/1.9 A)</b>	<b>6EP3322-6SB00-0AY0 (12 V/4.5 A)</b>	<b>6EP3321-6SB10-0AY0 (15 V/1.9 A)</b>
Input	1-phase AC or DC	1-phase AC or DC	1-phase AC or DC	1-phase AC or DC	1-phase AC or DC	1-phase AC or DC
Rated voltage $U_{in, rated}$ for AC	100 - 240 V	100 - 240 V	100 - 240 V	100 - 240 V	100 - 240 V	100 - 240 V
Voltage range for AC	85 - 264 V	85 - 264 V	85 - 264 V	85 - 264 V	85 - 264 V	85 - 264 V
Input voltage for DC	110 - 300 V	110 - 300 V	110 - 300 V	110 - 300 V	110 - 300 V	110 - 300 V
Wide-range input	Yes	Yes	Yes	Yes	Yes	Yes
Overvoltage resistance	300 V AC for 1 s	300 V AC for 1 s	300 V AC for 1 s	300 V AC for 1 s	300 V AC for 1 s	300 V AC for 1 s
Power failure buffering at $I_{out, rated}$ and $U_{in} = 187$ V: min.	40 ms	40 ms	40 ms	40 ms	40 ms	40 ms
Rated line frequency	50/60 Hz	50/60 Hz	50/60 Hz	50/60 Hz	50/60 Hz	50/60 Hz
Line frequency range	47 - 63 Hz	47 - 63 Hz	47 - 63 Hz	47 - 63 Hz	47 - 63 Hz	47 - 63 Hz
Input current at $U_{in, rated}$ 120 V	0.33 A	0.68 A	0.20 A	0.45 A	1.02 A	0.53 A
Input current at $U_{in, rated}$ 230 V	0.23 A	0.42 A	0.14 A	0.30 A	0.64 A	0.34 A
Inrush current limiting (25 °C), max.	26 A	51 A	20 A	25 A	50 A	25 A
$I^2t$ , max.	0.8 A <sup>2</sup> s	3 A <sup>2</sup> s	0.3 A <sup>2</sup> s	0.8 A <sup>2</sup> s	3 A <sup>2</sup> s	0.8 A <sup>2</sup> s

Technical data

6.1 Input

	<b>6EP3310-6SB00-0AY0</b> <b>(5 V/3 A)</b>	<b>6EP3311-6SB00-0AY0</b> <b>(5 V/6.3 A)</b>	<b>6EP3320-6SB00-0AY0</b> <b>(12 V/0.9 A)</b>	<b>6EP3321-6SB00-0AY0</b> <b>(12 V/1.9 A)</b>	<b>6EP3322-6SB00-0AY0</b> <b>(12 V/4.5 A)</b>	<b>6EP3321-6SB10-0AY0</b> <b>(15 V/1.9 A)</b>
Built-in line-side fuse	Internal	Internal	Internal	Internal	Internal	Internal
Protection in the line feeder cable (IEC 898)	Recommended miniature circuit-breaker: Characteristic B from 6 A or characteristic C from 2 A	Recommended miniature circuit-breaker: Characteristic B from 10 A or characteristic C from 6 A	Recommended miniature circuit-breaker: Characteristic B from 6 A or characteristic C from 2 A	Recommended miniature circuit-breaker: Characteristic B from 6 A or characteristic C from 2 A	Recommended miniature circuit-breaker: Characteristic B from 10 A or characteristic C from 6 A	Recommended miniature circuit-breaker: Characteristic B from 6 A or characteristic C from 2 A

	<b>6EP3322-6SB10-0AY0</b> <b>(15 V/4 A)</b>	<b>6EP3330-6SB00-0AY0</b> <b>(24 V/0.6 A)</b>	<b>6EP3331-6SB00-0AY0</b> <b>(24 V/1.3 A)</b>	<b>6EP3332-6SB00-0AY0</b> <b>(24 V/2.5 A)</b>	<b>6EP3333-6SB00-0AY0</b> <b>(24 V/4 A)</b>
Input	1-phase AC or DC	1-phase AC or DC	1-phase AC or DC	1-phase AC or DC	1-phase AC or DC
Rated voltage $U_{in \text{ rated}}$ for AC	100 - 240 V	100 - 240 V	100 - 240 V	100 - 240 V	100 - 240 V
Voltage range for AC	85 - 264 V	85 - 264 V	85 - 264 V	85 - 264 V	85 - 264 V
Input voltage for DC	110 - 300 V	110 - 300 V	110 - 300 V	110 - 300 V	110 - 300 V
Wide-range input	Yes	Yes	Yes	Yes	Yes
Overvoltage resistance	300 V AC for 1 s	300 V AC for 1 s	300 V AC for 1 s	300 V AC for 1 s	300 V AC for 1 s
Power failure buffering at $I_{out \text{ rated}}$ and $U_{in} = 187 \text{ V}$ : min.	40 ms	40 ms	40 ms	40 ms	40 ms
Rated line frequency	50/60 Hz	50/60 Hz	50/60 Hz	50/60 Hz	50/60 Hz
Line frequency range	47 - 63 Hz	47 - 63 Hz	47 - 63 Hz	47 - 63 Hz	47 - 63 Hz
Input current at $U_{in \text{ rated}}$ 120 V	1.10 A	0.25 A	0.56 A	1.08 A	1.70 A
Input current at $U_{in \text{ rated}}$ 230 V	0.70 A	0.16 A	0.37 A	0.70 A	1.00 A
Inrush current limiting (25 °C), max.	50 A	20 A	25 A	50 A	30 A
$I^2t$ , max.	3 A <sup>2</sup> s	0.5 A <sup>2</sup> s	0.8 A <sup>2</sup> s	3.3 A <sup>2</sup> s	2.5 A <sup>2</sup> s



	6EP3322-6SB10-0AY0 (15 V/4 A)	6EP3330-6SB00-0AY0 (24 V/0.6 A)	6EP3331-6SB00-0AY0 (24 V/1.3 A)	6EP3332-6SB00-0AY0 (24 V/2.5 A)	6EP3333-6SB00-0AY0 (24 V/4 A)
Built-in line-side fuse	Internal	Internal	Internal	Internal	Internal
Protection in the line feeder cable (IEC 898)	Recommended miniature circuit-breaker: Characteristic B from 10 A or characteristic C from 6 A	Recommended miniature circuit-breaker: Characteristic B from 6 A or characteristic C from 2 A	Recommended miniature circuit-breaker: Characteristic B from 6 A or characteristic C from 2 A	Recommended miniature circuit-breaker: Characteristic B from 10 A or characteristic C from 6 A	Recommended miniature circuit-breaker: Characteristic B from 10 A or characteristic C from 6 A

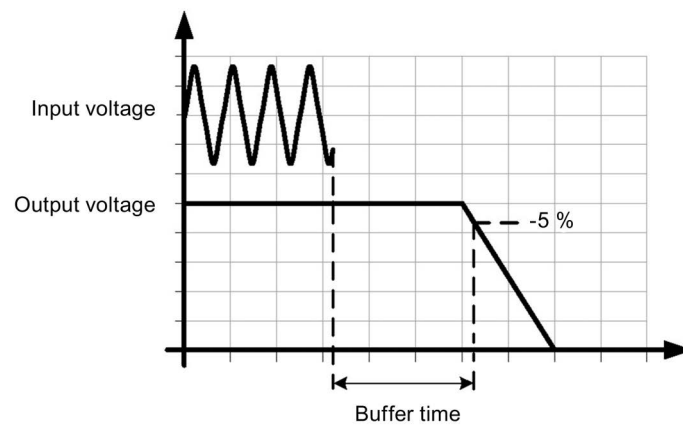

Figure 6-1 Mains buffering

## 6.2 Output

	<b>6EP3310- 6SB00-0AY0 (5 V/3 A)</b>	<b>6EP3311- 6SB00-0AY0 (5 V/6.3 A)</b>	<b>6EP3320- 6SB00-0AY0 (12 V/0.9 A)</b>	<b>6EP3321- 6SB00-0AY0 (12 V/1.9 A)</b>	<b>6EP3322- 6SB00-0AY0 (12 V/4.5 A)</b>	<b>6EP3321- 6SB10-0AY0 (15 V/1.9 A)</b>
Output	Regulated, isolated DC voltage					
Rated output voltage $U_{\text{out rated}}$ DC:	5 V	5 V	12 V	12 V	12 V	15 V
Total tolerance, static $\pm$	3 %	3 %	3 %	3 %	3 %	3 %
Static line regulation, approx.	0.1 %	0.1 %	0.1 %	0.1 %	0.1 %	0.1 %
Static load regulation, approx.	0.1 %	0.1 %	0.1 %	0.1 %	0.1 %	0.1 %
Residual ripple peak-peak, max.	100 mV	100 mV	200 mV	200 mV	200 mV	200 mV
Residual ripple peak-peak, typ.	30 mV	30 mV	30 mV	30 mV	30 mV	30 mV
Spikes peak-peak, max. (bandwidth, approx. 20 MHz)	100 mV	300 mV	300 mV	300 mV	300 mV	300 mV
Spikes peak-peak, typ. (bandwidth, approx. 20 MHz)	50 mV	50 mV	50 mV	50 mV	50 mV	50 mV
Setting range	4.6 - 5.4 V	4.6 - 5.4 V	-	10.5 - 16.1 V	10.5 - 16.1 V	10.5 - 16.1 V
Product function/output voltage can be adjusted	Yes	Yes	No	Yes	Yes	Yes
Output voltage setting	Using a potentiometer	Using a potentiometer	-	Using a potentiometer	Using a potentiometer	Using a potentiometer
Status display	Green LED for output voltage OK					
Response when switching on/off	No overshoot of $U_{\text{out}}$ (soft start)					
Starting delay, max.	0.5 s	0.5 s	0.5 s	0.5 s	0.5 s	0.5 s
Voltage rise, typ.	100 ms	100 ms	100 ms	100 ms	100 ms	100 ms
Rated current $I_{\text{out rated}}$	3 A	6.3 A	0.9 A	1.9 A	4.5 A	1.9 A

	<b>6EP3310-6SB00-0AY0</b> <b>(5 V/3 A)</b>	<b>6EP3311-6SB00-0AY0</b> <b>(5 V/6.3 A)</b>	<b>6EP3320-6SB00-0AY0</b> <b>(12 V/0.9 A)</b>	<b>6EP3321-6SB00-0AY0</b> <b>(12 V/1.9 A)</b>	<b>6EP3322-6SB00-0AY0</b> <b>(12 V/4.5 A)</b>	<b>6EP3321-6SB10-0AY0</b> <b>(15 V/1.9 A)</b>
Current range	0 - 3 A	0 - 6.3 A	0 - 0.9 A	0 - 1.9 A	0 - 4.5 A	0 - 1.9 A
• Remark	55 ... 70 °C: Derating 2 %/K	55 ... 70 °C: Derating 2 %/K	55 ... 70 °C: Derating 2 %/K	55 ... 70 °C: Derating 2 %/K	55 ... 70 °C: Derating 2 %/K	55 ... 70 °C: Derating 2 %/K
Output active power/typical	15 W	31.5 W	10.8 W	22.8 W	54 W	28.5 W
Can be connected in parallel to increase the power rating	Yes	Yes	No	Yes	Yes	Yes
Number of devices that can be connected in parallel, quantity	2	2	-	2	2	2
Output characteristic	see Figure 6-3 Output characteristic (Page 61)		see Figure 6-4 Output characteristic (12 V-0.9 A) (Page 62)	see Figure 6-3 Output characteristic (Page 61)		

	<b>6EP3322-6SB10-0AY0</b> <b>(15 V/4 A)</b>	<b>6EP3330-6SB00-0AY0</b> <b>(24 V/0.6 A)</b>	<b>6EP3331-6SB00-0AY0</b> <b>(24 V/1.3 A)</b>	<b>6EP3332-6SB00-0AY0</b> <b>(24 V/2.5 A)</b>	<b>6EP3333-6SB00-0AY0</b> <b>(24 V/4 A)</b>
Output	Regulated, isolated DC voltage				
Rated output voltage $U_{out\ rated\ DC}$ :	15 V	24 V	24 V	24 V	24 V
Total tolerance, static $\pm$	3 %	3 %	3 %	3 %	3 %
Static line regulation, approx.	0.1 %	0.1 %	0.1 %	0.1 %	0.1 %
Static load regulation, approx.	0.1 %	0.1 %	0.1 %	0.1 %	0.1 %
Residual ripple peak-peak, max.	200 mV	200 mV	200 mV	200 mV	200 mV
Residual ripple peak-peak, typ.	30 mV	30 mV	30 mV	30 mV	30 mV
Spikes peak-peak, max. (bandwidth, approx. 20 MHz)	300 mV	300 mV	300 mV	300 mV	300 mV
Spikes peak-peak, typ. (bandwidth, approx. 20 MHz)	50 mV	50 mV	50 mV	50 mV	50 mV
Setting range	10.5 - 16.1 V	-	22.2 - 26.4 V	22.2 - 26.4 V	22.2 - 26.4 V

Technical data

6.2 Output

	6EP3322-6SB10-0AY0 (15 V/4 A)	6EP3330-6SB00-0AY0 (24 V/0.6 A)	6EP3331-6SB00-0AY0 (24 V/1.3 A)	6EP3332-6SB00-0AY0 (24 V/2.5 A)	6EP3333-6SB00-0AY0 (24 V/4 A)
Product function/output voltage can be adjusted	Yes	No	Yes	Yes	Yes
Output voltage setting	Using a potentiometer	-	Using a potentiometer	Using a potentiometer	Using a potentiometer
Status display	Green LED for output voltage OK				
Response when switching on/off	No overshoot of $U_{out}$ (soft start)				
Starting delay, max.	0.5 s	0.5 s	0.5 s	0.5 s	0.5 s
Voltage rise, typ.	100 ms	100 ms	100 ms	100 ms	100 ms
Rated current $I_{out rated}$	4 A	0.6 A	1.3 A	2.5 A	4 A
Current range	0 - 4 A	0 - 0.6 A	0 - 1.3 A	0 - 2.5 A	0 - 4 A
• Remark	55 ... 70 °C: Derating 2%/K	55 ... 70 °C: Derating 2%/K	55 ... 70 °C: Derating 2%/K	55 ... 70 °C: Derating 2%/K	55 ... 70 °C: Derating 2%/K
Output active power/typical	60 W	14.4 W	31.2 W	60 W	96 W
Can be connected in parallel to increase the power rating	Yes	No	Yes	Yes	Yes
Number of devices that can be connected in parallel, quantity	2	-	2	2	2
Output characteristic	see Figure 6-3 Output characteristic (Page 61)	see Figure 6-5 Output characteristic (24 V-0.6 A) (Page 62)	see Figure 6-3 Output characteristic (Page 61)		

## Run-up

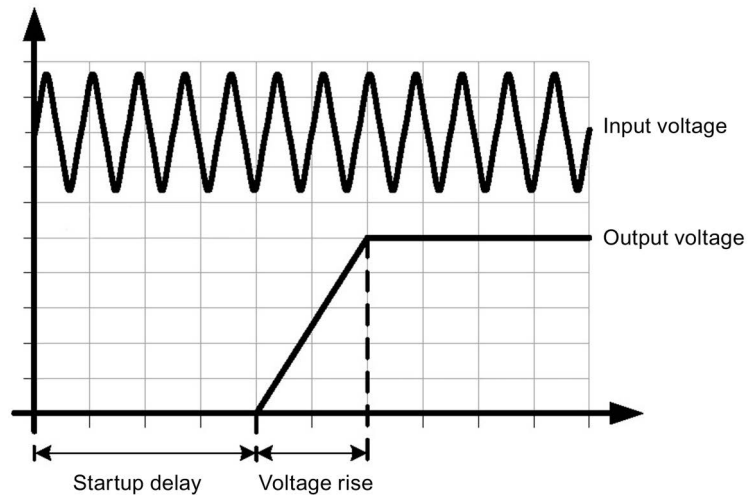

Figure 6-2 Startup delay/voltage rise

## Output characteristic for 36 mm, 54 mm and 72 mm devices

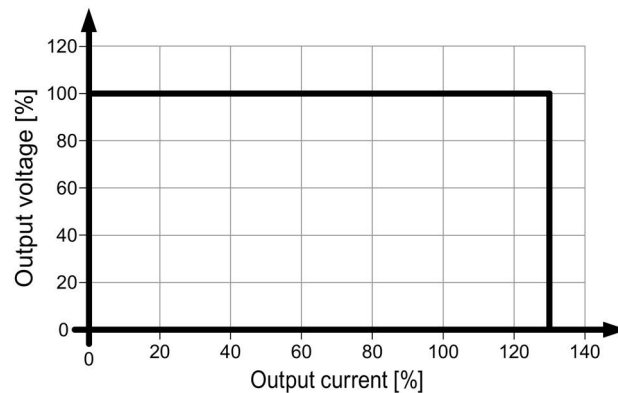

Figure 6-3 Output characteristic

The device supplies a constant output voltage until the current limit is reached. In the event of an overload, the output current and the output voltage are reduced. The device does not switch off.

### Output characteristic for 18 mm devices

#### Output characteristic 12 V devices

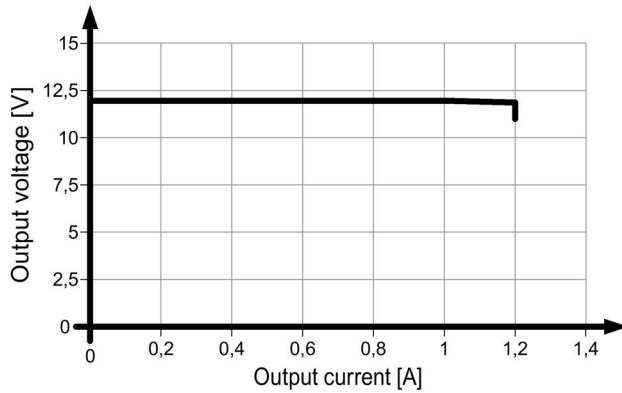

Figure 6-4 Output characteristic (12 V-0.9 A)

#### Output characteristic for 24 mm devices

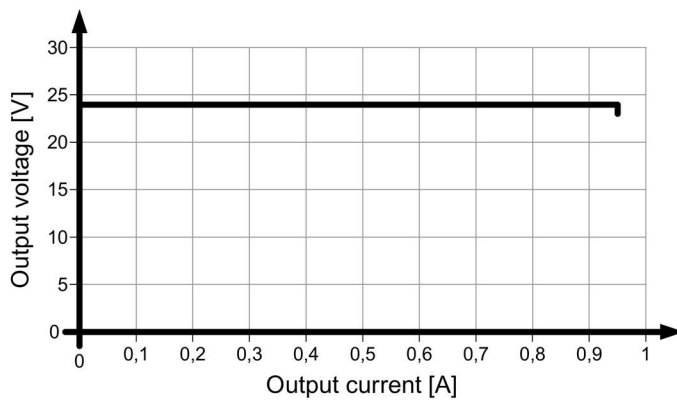

Figure 6-5 Output characteristic (24 V-0.6 A)

The device supplies a constant output voltage until the current limit is reached. In the event of an overload, the output current and the output voltage are reduced. When the output current is exceeded by approximately 1.5x, the device shuts down and automatically restarts after approximately 1 - 1.5 s. This response is repeated as long as the overload condition is present.

### 6.3 Efficiency and power loss

	6EP3310-6SB00-0AY0 (5 V/3 A)	6EP3311-6SB00-0AY0 (5 V/6.3 A)	6EP3320-6SB00-0AY0 (12 V/0.9 A)	6EP3321-6SB00-0AY0 (12 V/1.9 A)	6EP3322-6SB00-0AY0 (12 V/4.5 A)	6EP3321-6SB10-0AY0 (15 V/1.9 A)
Efficiency at $U_{out rated}, I_{out rated},$ approx.	75 %	78 %	78 %	81 %	87 %	83 %
Power loss at $U_{out rated}, I_{out rated},$ approx.	5 W	8.7 W	3 W	5.4 W	8.2 W	6 W

	6EP3322-6SB10-0AY0 (15 V/4 A)	6EP3330-6SB00-0AY0 (24 V/0.6 A)	6EP3331-6SB00-0AY0 (24 V/1.3 A)	6EP3332-6SB00-0AY0 (24 V/2.5 A)	6EP3333-6SB00-0AY0 (24 V/4 A)
Efficiency at $U_{out rated}, I_{out rated},$ approx.	88 %	85 %	86 %	90 %	89 %
Power loss at $U_{out rated}, I_{out rated},$ approx.	8 W	2.6 W	5 W	7 W	12 W

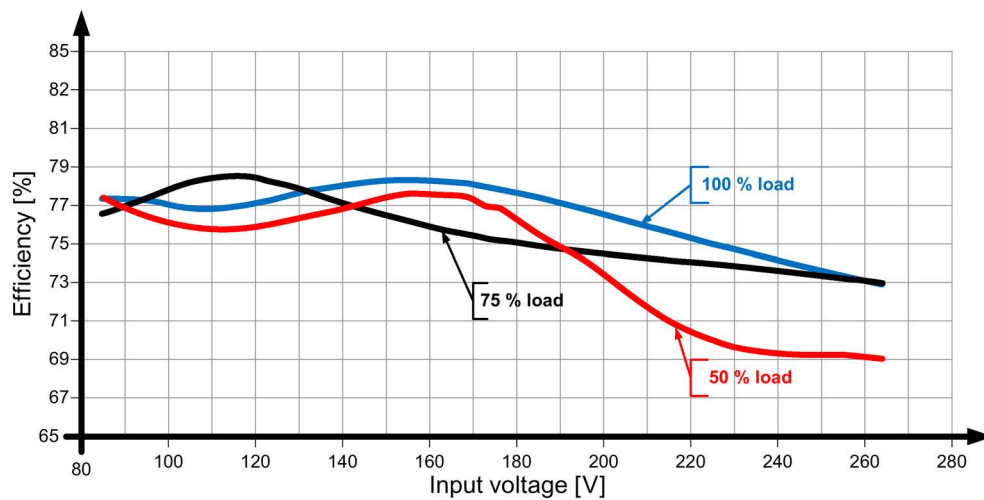

Figure 6-6 6EP3310-6SB00-0AY0 (5 V/3 A)

6.3 Efficiency and power loss

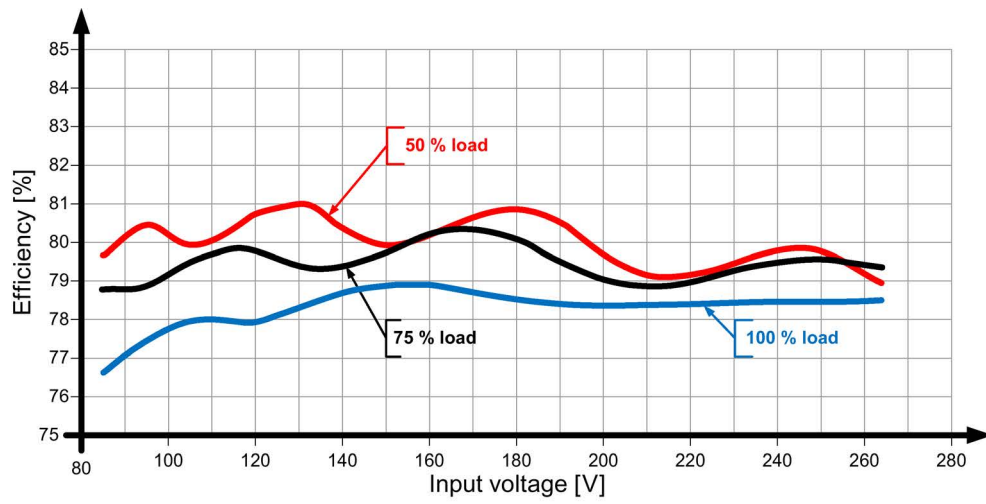

Figure 6-7 6EP3311-6SB00-0AY0 (5 V/6.3 A)

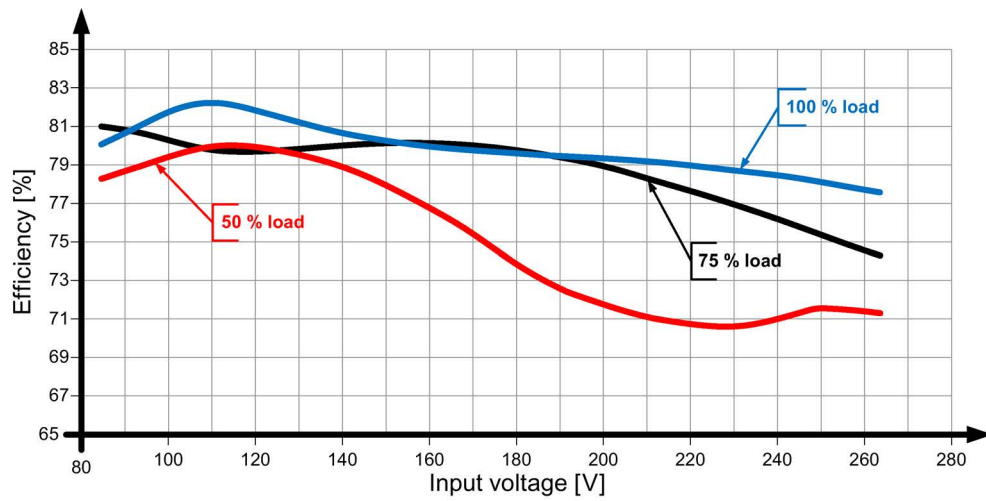

Figure 6-8 6EP3320-6SB00-0AY0 (12 V/0.9 A)



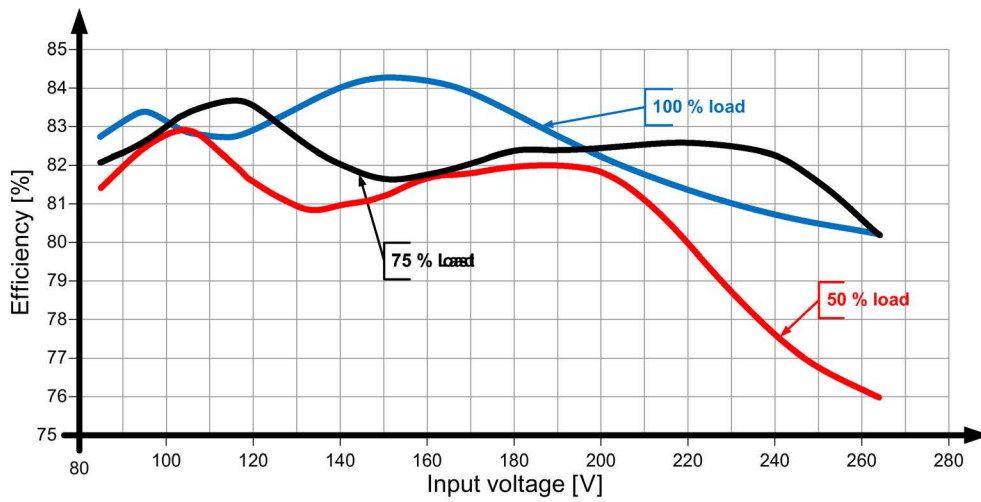

Figure 6-9 6EP3321-6SB00-0AY0 (12 V/1.9 A)

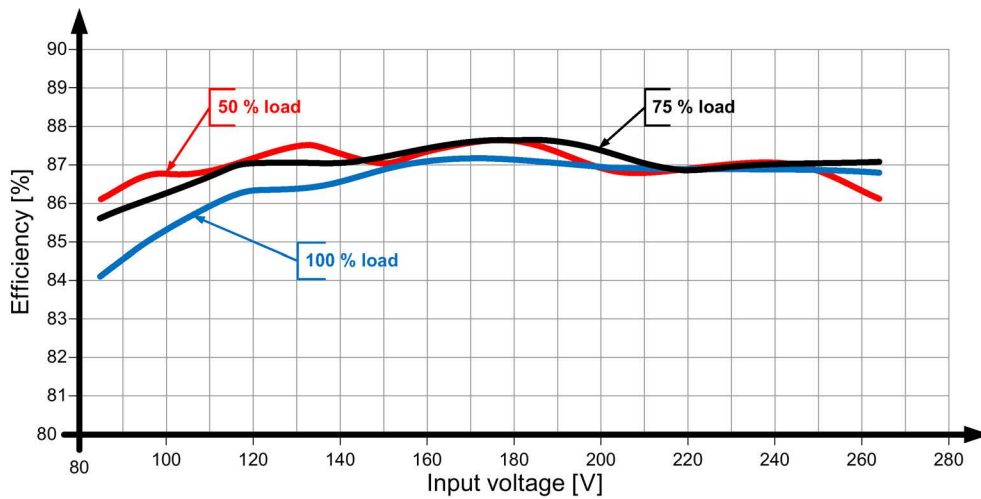

Figure 6-10 6EP3322-6SB00-0AY0 (12 V/4.5 A)

6.3 Efficiency and power loss

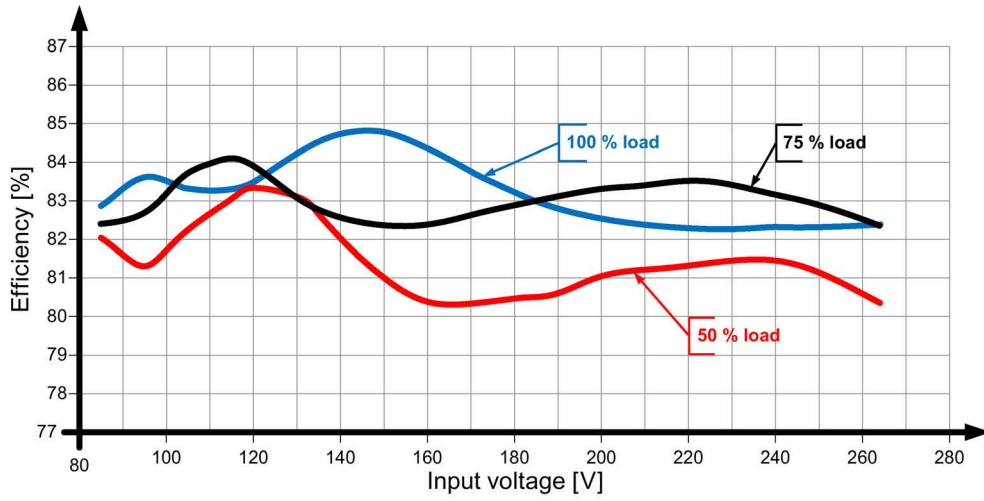

Figure 6-11 6EP3321-6SB10-0AY0 (15 V/1.9 A)

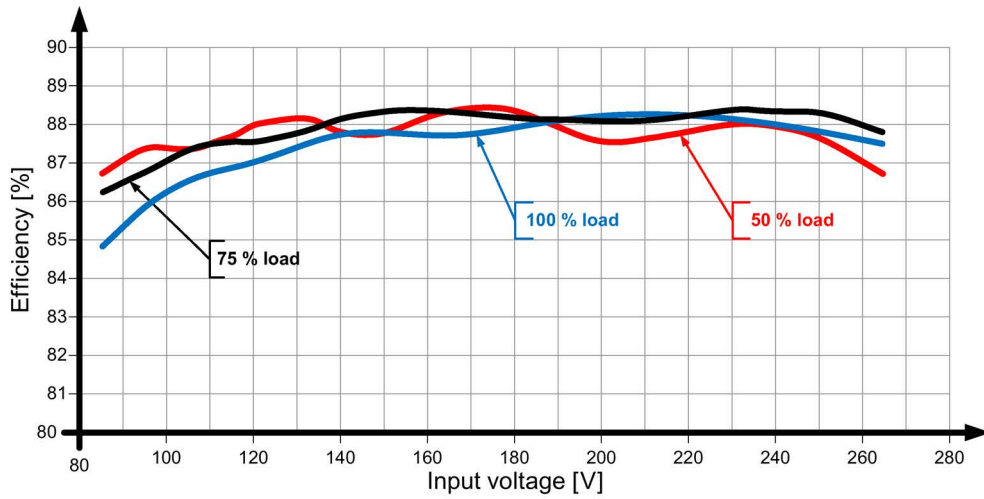

Figure 6-12 6EP3322-6SB10-0AY0 (15 V/4 A)

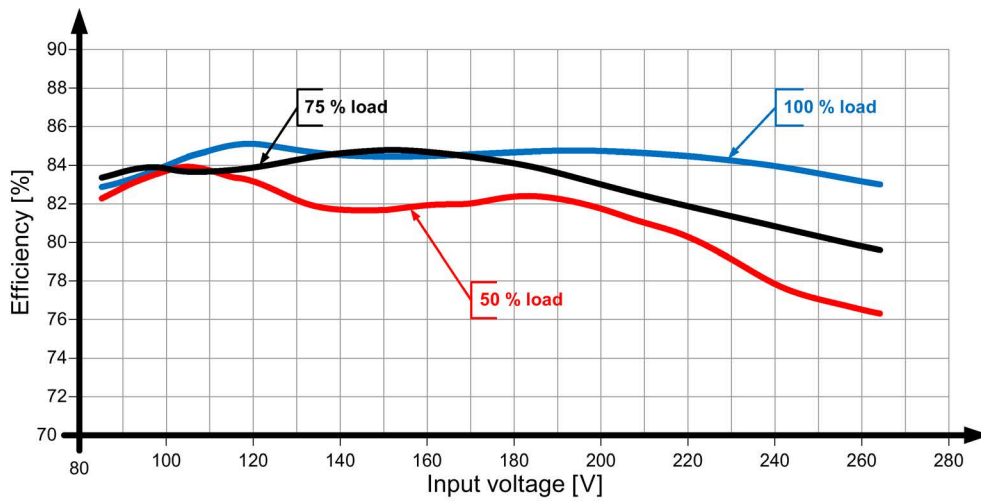

Figure 6-13 6EP3330-6SB00-0AY0 (24 V/0.6 A)

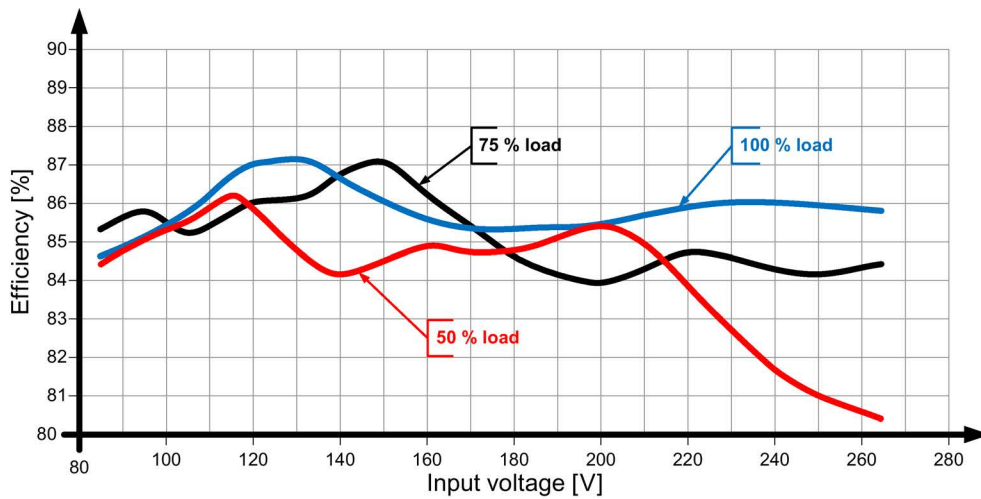

Figure 6-14 6EP3331-6SB00-0AY0 (24 V/1.3 A)

6.3 Efficiency and power loss

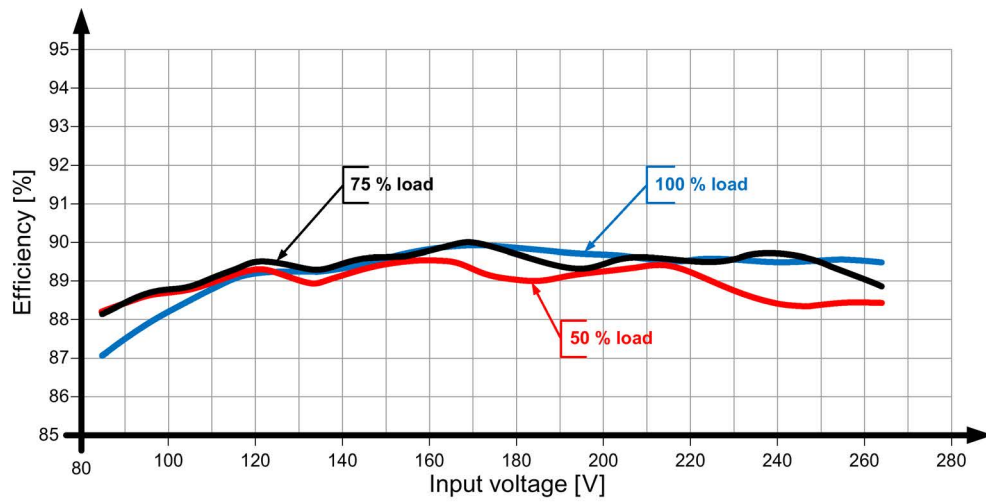

Figure 6-15 6EP3332-6SB00-0AY0 (24 V/2.5 A)

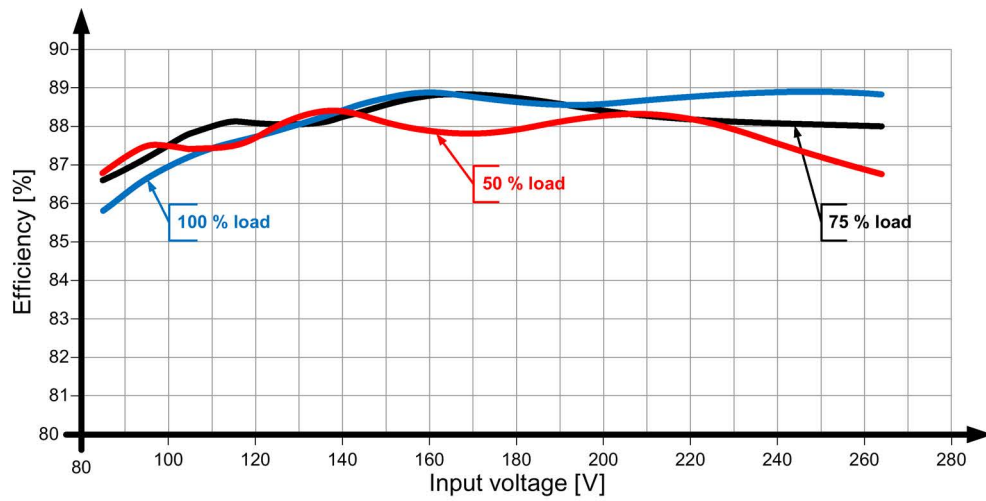

Figure 6-16 6EP3333-6SB00-0AY0 (24 V/4 A)

## 6.4 Closed-loop control

	6EP3310-6SB00-0AY0 (5 V/3 A)	6EP3311-6SB00-0AY0 (5 V/6.3 A)	6EP3320-6SB00-0AY0 (12 V/0.9 A)	6EP3321-6SB00-0AY0 (12 V/1.9 A)	6EP3322-6SB00-0AY0 (12 V/4.5 A)	6EP3321-6SB10-0AY0 (15 V/1.9 A)
Dynamic line regulation ( $U_{in rated} \pm 15\%$ )	0.2 %	0.2 %	0.2 %	0.2 %	0.2 %	0.2 %
Dyn. load regulation ( $I_{out}$ : 10/90/10 %), $U_{out} \pm$ typ.	5 %	7 %	3 %	2 %	4 %	2 %
Load step regulation time 10 to 90 %, typ.	1 ms	1 ms	1 ms	1 ms	1 ms	1 ms
Load step regulation time 90 to 10 %, typ.	1 ms	1 ms	1 ms	1 ms	1 ms	1 ms

	6EP3322-6SB10-0AY0 (15 V/4 A)	6EP3330-6SB00-0AY0 (24 V/0.6 A)	6EP3331-6SB00-0AY0 (24 V/1.3 A)	6EP3332-6SB00-0AY0 (24 V/2.5 A)	6EP3333-6SB00-0AY0 (24 V/4 A)
Dynamic line regulation ( $U_{in rated} \pm 15\%$ )	0.2 %	0.2 %	0.2 %	0.2 %	0.2 %
Dyn. load regulation ( $I_{out}$ : 10/90/10 %), $U_{out} \pm$ typ.	3 %	2 %	1 %	2 %	2 %
Load step regulation time 10 to 90 %, typ.	1 ms	1 ms	1 ms	1 ms	1 ms
Load step regulation time 90 to 10 %, typ.	1 ms	1 ms	1 ms	1 ms	1 ms

## 6.5 Protection and monitoring

	6EP3310-6SB00-0AY0 (5 V/3 A)	6EP3311-6SB00-0AY0 (5 V/6.3 A)	6EP3320-6SB00-0AY0 (12 V/0.9 A)	6EP3321-6SB00-0AY0 (12 V/1.9 A)	6EP3322-6SB00-0AY0 (12 V/4.5 A)	6EP3321-6SB10-0AY0 (15 V/1.9 A)
Output over-voltage protection	Yes, according to EN 60950-1					
Current limitation, typ.	3.8 A	8.2 A	1.3 A	2.5 A	5 A	2.5 A
Property of the output/short-circuit proof	Yes					
Short-circuit protection	Constant current characteristic	Constant current characteristic	Shutdown, restart after 1 - 1.5 s	Constant current characteristic	Constant current characteristic	Constant current characteristic
Continuous short-circuit current/rms value/maximum	3.8 A	8.2 A	1.3 A	2.5 A	5 A	2.5 A

	6EP3322-6SB10-0AY0 (15 V/4 A)	6EP3330-6SB00-0AY0 (24 V/0.6 A)	6EP3331-6SB00-0AY0 (24 V/1.3 A)	6EP3332-6SB00-0AY0 (24 V/2.5 A)	6EP3333-6SB00-0AY0 (24 V/4 A)
Output overvoltage protection	Yes, according to EN 60950-1				
Current limitation, typ.	5 A	0.8 A	1.7 A	3.2 A	5 A
Property of the output/short-circuit proof	Yes				
Short-circuit protection	Constant current characteristic	Shutdown, restart after 1 - 1.5 s	Constant current characteristic	Constant current characteristic	Constant current characteristic
Continuous short-circuit current/rms value/maximum	5 A	0.8 A	1.7 A	5 A	3.2 A

## 6.6 MTBF

	6EP3310- 6SB00-0AY0 (5 V/3 A)	6EP3311- 6SB00-0AY0 (5 V/6.3 A)	6EP3320- 6SB00-0AY0 (12 V/0.9 A)	6EP3321- 6SB00-0AY0 (12 V/1.9 A)	6EP3322- 6SB00-0AY0 (12 V/4.5 A)	6EP3321- 6SB10-0AY0 (15 V/1.9 A)
Mean Time Between Failures SN29500 (at 40 °C, rated load, 24 h operation)	2,900,000	2,700,000	3,800,000	2,900,000	2,600,000	2,900,000

	6EP3322- 6SB10-0AY0 (15 V/4 A)	6EP3330- 6SB00-0AY0 (24 V/0.6 A)	6EP3331- 6SB00-0AY0 (24 V/1.3 A)	6EP3332- 6SB00-0AY0 (24 V/2.5 A)	6EP3333- 6SB00-0AY0 (24 V/4 A)
Mean Time Between Failures SN29500 (at 40 °C, rated load, 24 h operation)	2,600,000	4,400,000	3,100,000	2,900,000	2,400,000

## 6.7 Mechanical system

	6EP3320-6SB00-0AY0 (12 V/0.9 A)	6EP3310-6SB00-0AY0 (5 V/3 A)	6EP3311-6SB00-0AY0 (5 V/6.3 A)	6EP3333-6SB00-0AY0 (24 V/4 A)
	6EP3330-6SB00-0AY0 (24 V/0.6 A)	6EP3321-6SB00-0AY0 (12 V/1.9 A)	6EP3322-6SB00-0AY0 (12 V/4.5 A)	
		6EP3321-6SB10-0AY0 (15 V/1.9 A)	6EP3322-6SB10-0AY0 (15 V/4 A)	
		6EP3331-6SB00-0AY0 (24 V/1.3 A)	6EP3332-6SB00-0AY0 (24 V/2.5 A)	
Connection system	screw-type terminal			
Connections / line supply	L, N: 1 screw terminal each for 0.14 - 2.5 mm <sup>2</sup> solid/finely stranded		L, N: 1 screw terminal each for 0.05 - 2.5 mm <sup>2</sup> solid/finely stranded	
Connections / output	+, -: 1 screw terminal each for 0.14 - 2.5 mm <sup>2</sup>		+, -: 2 screw terminals each for 0.05 - 2.5 mm <sup>2</sup>	
Width of the housing	18 mm	36 mm	54 mm	72 mm
Height of the housing	90 mm	90 mm	90 mm	90 mm
Depth of the housing	53 mm	53 mm	53 mm	53 mm
Installation width	18 mm	36 mm	54 mm	72 mm
Mounting height	130 mm	130 mm	130 mm	130 mm
Weight, approx.	0.07 kg	0.12 kg	0.2 kg	0.29 kg
Product feature / of the housing / housing that can be lined up next to one another	Yes			
Type of mounting / panel mounting	Yes			
Type of mounting / rail mounting	Yes			
Type of mounting / S7-300 rail mounting	No			
Mounting	Can be snapped onto standard EN 60715 35×7,5/15 mounting rails			



## 6.8 Dimension drawing

See Section Dimensions and weight (Page 17)

CAD data that can be downloaded from the Internet:

6EP3310-6SB00-0AY0

[http://www.automation.siemens.com/bilddb/index.aspx?gridview=view2&objkey=G\\_KT01\\_X\\_X\\_01275&showdetail=true&view=Search](http://www.automation.siemens.com/bilddb/index.aspx?gridview=view2&objkey=G_KT01_X_X_01275&showdetail=true&view=Search)

6EP3311-6SB00-0AY0

[http://www.automation.siemens.com/bilddb/index.aspx?gridview=view2&objkey=G\\_KT01\\_X\\_X\\_01278&showdetail=true&view=Search](http://www.automation.siemens.com/bilddb/index.aspx?gridview=view2&objkey=G_KT01_X_X_01278&showdetail=true&view=Search)

6EP3320-6SB00-0AY0

[http://www.automation.siemens.com/bilddb/index.aspx?gridview=view2&objkey=G\\_KT01\\_X\\_X\\_01306&showdetail=true&view=Search](http://www.automation.siemens.com/bilddb/index.aspx?gridview=view2&objkey=G_KT01_X_X_01306&showdetail=true&view=Search)

6EP3321-6SB00-0AY0

[http://www.automation.siemens.com/bilddb/index.aspx?gridview=view2&objkey=G\\_KT01\\_X\\_X\\_01281&showdetail=true&view=Search](http://www.automation.siemens.com/bilddb/index.aspx?gridview=view2&objkey=G_KT01_X_X_01281&showdetail=true&view=Search)

6EP3322-6SB00-0AY0

[http://www.automation.siemens.com/bilddb/index.aspx?gridview=view2&objkey=G\\_KT01\\_X\\_X\\_01284&showdetail=true&view=Search](http://www.automation.siemens.com/bilddb/index.aspx?gridview=view2&objkey=G_KT01_X_X_01284&showdetail=true&view=Search)

6EP3321-6SB10-0AY0

[http://www.automation.siemens.com/bilddb/index.aspx?gridview=view2&objkey=G\\_KT01\\_X\\_X\\_01287&showdetail=true&view=Search](http://www.automation.siemens.com/bilddb/index.aspx?gridview=view2&objkey=G_KT01_X_X_01287&showdetail=true&view=Search)

6EP3322-6SB10-0AY0

[http://www.automation.siemens.com/bilddb/index.aspx?gridview=view2&objkey=G\\_KT01\\_X\\_X\\_01290&showdetail=true&view=Search](http://www.automation.siemens.com/bilddb/index.aspx?gridview=view2&objkey=G_KT01_X_X_01290&showdetail=true&view=Search)

6EP3330-6SB00-0AY0

[http://www.automation.siemens.com/bilddb/index.aspx?gridview=view2&objkey=G\\_KT01\\_X\\_X\\_01303&showdetail=true&view=Search](http://www.automation.siemens.com/bilddb/index.aspx?gridview=view2&objkey=G_KT01_X_X_01303&showdetail=true&view=Search)

6EP3331-6SB00-0AY0

[http://www.automation.siemens.com/bilddb/index.aspx?gridview=view2&objkey=G\\_KT01\\_X\\_X\\_01293&showdetail=true&view=Search](http://www.automation.siemens.com/bilddb/index.aspx?gridview=view2&objkey=G_KT01_X_X_01293&showdetail=true&view=Search)

6EP3332-6SB00-0AY0

[http://www.automation.siemens.com/bilddb/index.aspx?gridview=view2&objkey=G\\_KT01\\_X\\_X\\_01296&showdetail=true&view=Search](http://www.automation.siemens.com/bilddb/index.aspx?gridview=view2&objkey=G_KT01_X_X_01296&showdetail=true&view=Search)

6EP3333-6SB00-0AY0

[http://www.automation.siemens.com/bilddb/index.aspx?gridview=view2&objkey=G\\_KT01\\_X\\_X\\_01299&showdetail=true&view=Search](http://www.automation.siemens.com/bilddb/index.aspx?gridview=view2&objkey=G_KT01_X_X_01299&showdetail=true&view=Search)



## Safety, approvals, EMC

### 7.1 Safety

	6EP3310-6SB00-0AY0 (5 V/3 A)	6EP3322-6SB10-0AY0 (15 V/4 A)
	6EP3311-6SB00-0AY0 (5 V/6.3 A)	6EP3330-6SB00-0AY0 (24 V/0.6 A)
	6EP3320-6SB00-0AY0 (12 V/0.9 A)	6EP3331-6SB00-0AY0 (24 V/1.3 A)
	6EP3321-6SB00-0AY0 (12 V/1.9 A)	6EP3332-6SB00-0AY0 (24 V/2.5 A)
	6EP3322-6SB00-0AY0 (12 V/4.5 A)	6EP3333-6SB00-0AY0 (24 V/4 A)
	6EP3321-6SB10-0AY0 (15 V/1.9 A)	
Primary/secondary galvanic isolation	Yes	
Electrical isolation	SELV output voltage $U_{out}$ acc. to EN 60950-1 and EN 50178	
Protection class	Class II (without protective conductor)	
Degree of protection (EN 60529)	IP20	
Test voltage	See Section Test voltage (Page 76)	

## 7.2 Test voltage

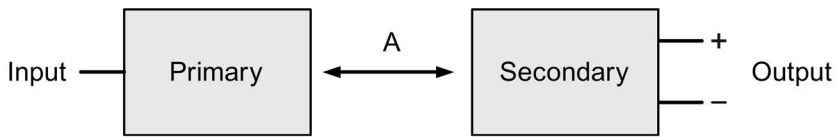

Figure 7-1 Test voltage diagram

Only the manufacturer can perform the type test and production test; users can also perform the field test.

Preconditions for performing the field test:

Test (A)

- Connect the input terminals to one another
- Connect the output terminals to one another

Table 7- 1 Test voltage

	Test time	Prim ↔ sec (A)
Type test	60 s	4200 V DC
	60 s	3000 V AC
Production test	1 s	4200 V DC
	1 s	3000 V AC
Field test	1 s	2200 V DC
	1 s	1500 V AC

Remark:

Tripping current for DC measurement: 0 mA

Tripping current for AC measurement: < 100 mA

## 7.3 Certifications

Certifications	6EP3310-6SB00-0AY0 (5 V/3 A)	6EP3320-6SB00-0AY0 (12 V/0.9 A)	6EP3311-6SB00-0AY0 (5 V/6.3 A)
	6EP3321-6SB00-0AY0 (12 V/1.9 A)	6EP3322-6SB00-0AY0 (12 V/4.5 A)	6EP3333-6SB00-0AY0 (24 V/4 A)
	6EP3321-6SB10-0AY0 (15 V/1.9 A)	6EP3322-6SB10-0AY0 (15 V/4 A)	
	6EP3331-6SB00-0AY0 (24 V/1.3 A)	6EP3330-6SB00-0AY0 (24 V/0.6 A)	6EP3332-6SB00-0AY0 (24 V/2.5 A)
CE marking	Yes	Yes	Yes
UL/cUL approval	cULus-Listed (UL 508, CSA C22.2 No.107.1), File E197259 NEC class2 (to UL 60950-1/UL 1310), File E151273		cULus-Listed (UL 508, CSA C22.2 No.107.1), File E197259
UL/CSA approval	cURus-Recognized (UL 60950-1, CSA C22.2 No. 60950-1) File E151273 CSA 22.2 N060950 cCSAus		
FM	Class I, Div. 2, Group ABCD, T4 being prepared		
CB approval	Yes	Yes	Yes
Explosion protection	ATEX II 3G Ex ic nA IIC T4 UL/cUL: ANSI/ISA- 12.12.01-2015) Class I, Div. 2, Group ABCD, T4	ATEX II 3G Ex ic nA IIC T3 UL/cUL: ANSI/ISA-12.12.01-2015) Class I, Div. 2, Group ABCD, T4	
IECEX approval	Yes	Yes	Yes
SEMI F47 compliance 208 V-240 V	IEC 61000-4-11	EC 61000-4-11	EC 61000-4-11
Marine approval	6EP3310-6SB00-0AY0, 6EP3311-6SB00-0AY0, 6EP3320-6SB00-0AY0 6EP3321-6SB00-0AY0, 6EP3322-6SB00-0AY0 DNV-GL, ABS being prepared 6EP3321-6SB10-0AY0, 6EP3322-6SB10-0AY0, 6EP3330-6SB00-0AY0 6EP3331-6SB00-0AY0, 6EP3332-6SB00-0AY0, 6EP3333-6SB00-0AY0 DNV-GL, ABS, BV, LRS being prepared		

## 7.4 EMC

		6EP3310-6SB00-0AY0 (5 V/3 A)
		6EP3311-6SB00-0AY0 (5 V/6.3 A)
		6EP3320-6SB00-0AY0 (12 V/0.9 A)
		6EP3321-6SB00-0AY0 (12 V/1.9 A)
		6EP3322-6SB00-0AY0 (12 V/4.5 A)
		6EP3321-6SB10-0AY0 (15 V/1.9 A)
		6EP3322-6SB10-0AY0 (15 V/4 A)
		6EP3330-6SB00-0AY0 (24 V/0.6 A)
		6EP3331-6SB00-0AY0 (24 V/1.3 A)
		6EP3332-6SB00-0AY0 (24 V/2.5 A)
		6EP3333-6SB00-0AY0 (24 V/4 A)
Generic standards	EN 61000-6-2	Immunity for industrial environments
	EN 61000-6-3	Emission for residential areas
Electrostatic discharges	EN 61000-4-2	8 kV contact, 8 kV air
Electromagnetic fields	EN 61000-4-3	80 - 1000 MHz 10 V/m
		1000 - 2000 MHz 3 V/m
		2000 - 2700 MHz 1 V/m
High-speed transient disturbance variables (burst)	EN 61000-4-4	4 kV on line connections
		2 kV at DC output
Power surges	EN 61000-4-5	2 kV symmetrical on line connections
		4 kV asymmetrical on line connections
		500 V symmetrical/asymmetrical on DC output cables
High-frequency fields	EN 61000-4-6	10 V; 0.15 - 80 MHz
Voltage dips	EN 61000-4-11	100% for 20 ms
		60% for 200 ms
		30% for 500 ms
Voltage interruptions	EN 61000-4-11	100% for 5000 ms
Emitted interference	EN 55022	Class B
Line harmonics limitation	EN 61000-3-2	Not applicable
Noise immunity	EN 61000-6-2	

## Ambient conditions

	<p>6EP3310-6SB00-0AY0 (5 V/3 A)      6EP3322-6SB10-0AY0 (15 V/4 A)</p> <p>6EP3311-6SB00-0AY0 (5 V/6.3 A)      6EP3330-6SB00-0AY0 (24 V/0.6 A)</p> <p>6EP3320-6SB00-0AY0 (12 V/0.9 A)      6EP3331-6SB00-0AY0 (24 V/1.3 A)</p> <p>6EP3321-6SB00-0AY0 (12 V/1.9 A)      6EP3332-6SB00-0AY0 (24 V/2.5 A)</p> <p>6EP3322-6SB00-0AY0 (12 V/4.5 A)      6EP3333-6SB00-0AY0 (24 V/4 A)</p> <p>6EP3321-6SB10-0AY0 (15 V/1.9 A)</p>
Ambient temperature	<p>-25 ... 70 °C for natural convection (self convection)</p> <p>Tested according to:</p> <ul style="list-style-type: none"> <li>• EN 60068-2-1 Cold</li> <li>• EN 60068-2-2 Dry heat</li> <li>• EN 60068-2-78 Humid heat, constant</li> <li>• EN 60068-2-14 Temperature change</li> </ul>
Transport and storage temperature	<p>-40 ... 85 °C</p> <p>Tests (packed for shipping) according to:</p> <ul style="list-style-type: none"> <li>• EN 60068-2-1 Cold</li> <li>• EN 60068-2-2 Dry heat</li> <li>• EN 60068-2-30 Humid heat, cyclic</li> </ul>
Humidity class	Climatic class 3K3 according to EN 60721, 5 - 95 % no condensation
Degree of pollution	2
Mechanical stressing in operation	<p>Tested according to:</p> <ul style="list-style-type: none"> <li>• EN 60068-2-6 Vibration, test Fc <ul style="list-style-type: none"> <li>– 7 mm deflection in the range 5 – 9 Hz</li> <li>– 2 g acceleration in the range 9 – 150 Hz</li> </ul> </li> <li>• EN 60068-2-27 Shock, test Ea <ul style="list-style-type: none"> <li>– Acceleration 150 m/s<sup>2</sup>, test duration 11 ms</li> </ul> </li> </ul>

6EP3310-6SB00-0AY0 (5 V/3 A)	6EP3322-6SB10-0AY0 (15 V/4 A)
6EP3311-6SB00-0AY0 (5 V/6.3 A)	6EP3330-6SB00-0AY0 (24 V/0.6 A)
6EP3320-6SB00-0AY0 (12 V/0.9 A)	6EP3331-6SB00-0AY0 (24 V/1.3 A)
6EP3321-6SB00-0AY0 (12 V/1.9 A)	6EP3332-6SB00-0AY0 (24 V/2.5 A)
6EP3322-6SB00-0AY0 (12 V/4.5 A)	6EP3333-6SB00-0AY0 (24 V/4 A)
6EP3321-6SB10-0AY0 (15 V/1.9 A)	

Damaging gases

Tested according to:

- EN 60068-2-42 Sulfur dioxide: 10 cm<sup>3</sup>/m<sup>3</sup>, 4 days
- EN 60068-2-43 Hydrogen sulfide: 1 cm<sup>3</sup>/m<sup>3</sup>, 4 days

Atmospheric pressure

Operation:

- 1080 - 795 hPa (-1000 - 2000 m)
- For operation at altitudes of 2000 m up to 6000 m above sea level: output power must be derated by -7.5% / 1000 m or the ambient temperature must be reduced by 5 K / 1000 m see Figure 4-12 Mounting height derating (Page 27)
- Overvoltage category:
  - III up to 2000 m (EN 50178)
  - II from 2000 m up to 6000 m (EN 50178)

Storage:

- 1080 - 660 hPa (-1000 - 3500 m)



# Applications

## 9.1 Parallel connection to increase power rating

To enhance performance, two LOGO!Power power supplies of the same type can be galvanically connected in parallel.

### Note

It is not permissible to connect 6EP3320-6SB00-0AY0 (12 V/0.9 A) and 6EP3330-6SB00-0AY0 (24 V/0.6 A) in parallel.

The following must be observed:

- The cables connected to each power supply at terminals "+" and "-" must have identical lengths and the same cable cross-sections (or the same impedance) up to a common external network junction (terminal strip) if possible.
- The power supplies connected in parallel must be switched on simultaneously with a common switch in the line feeder cable (e.g. with the main switch available in control cabinets).
- The output voltages measured in no-load operation for the power supplies that are not yet connected in parallel should not deviate more than a maximum of 0.2 %. This usually corresponds to the factory setting. If the output voltage is changed, you should connect the "-" terminals and then, in no-load operation, measure the voltage difference between the "+" terminals that have not yet been connected. This voltage difference should not exceed 0.2 % of  $U_{out}$ .

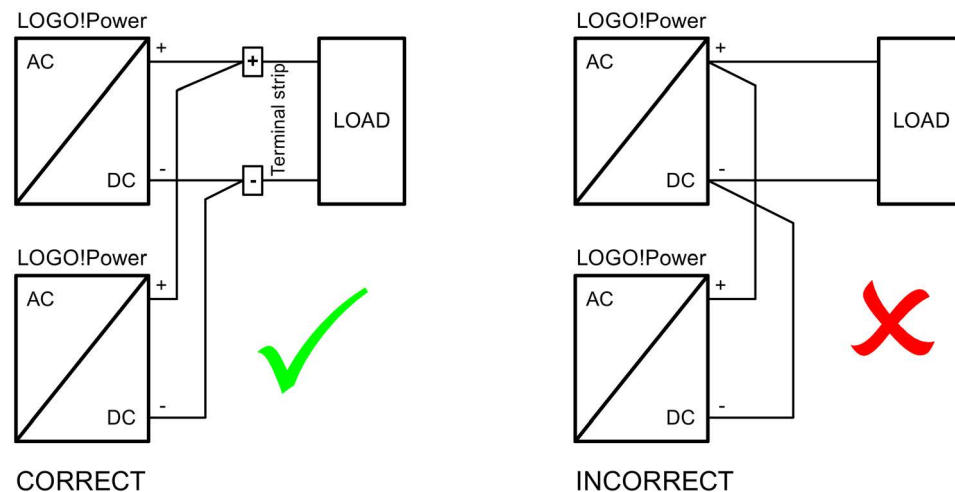

Figure 9-1 Parallel connection, correct and incorrect

**NOTICE**

**Protective circuit for the parallel connection of more than two power supplies**

For connection of more than two power supplies in parallel, additional measures must be taken to prevent high backward feeding currents in the event of a secondary device fault. For this purpose, a suitable protective circuit (e.g. decoupling diode or DC-conform circuit-breaker) must be installed between each "+" terminal of the power supply and the common connection point.

## 9.2 Parallel connection for redundancy

The parallel switching of several LOGO!Power power supplies of the same type for redundancy is required when the demands for reliability of the supply are particularly high.

If a component in the redundant supply fails, the power supply for the loads must be fully accommodated by the remaining component. It is therefore important when dimensioning the system to make sure that  $n+1$  redundant switched power supplies can handle the total power requirement of the remaining  $n$  power supplies.

To prevent loading of the remaining power supplies in the event of a secondary-side error when one power supply fails, the respective "+" terminals of the power supplies must be decoupled via diodes.

---

### Note

For a high reliability of the supply, it is recommended that the redundant switched power supplies are fused separately on the line-side and, if possible, be connected to different power supply networks.

---

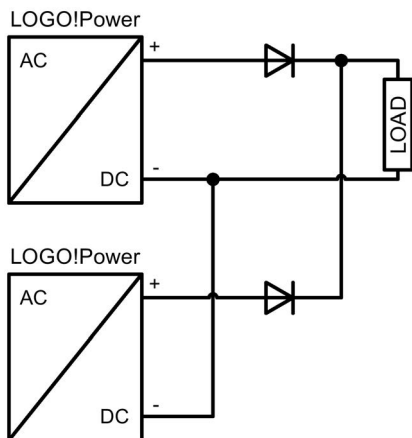

Figure 9-2 Parallel connection for redundancy

### 9.3 Series connection for increased voltage

To achieve a higher output voltage, two LOGO!Power power supplies of the same type can be connected in series. In this case, connect the "-" terminal of the first power supply to the "+" terminal of the second power supply. The "+" terminal of the first power supply and the "-" terminal of the second power supply are routed to the load.

Depending on grounding point of the secondary output voltage, voltages of  $+2 \times U_A$ ,  $\pm U_A$  or  $-2 \times U_A$  can be implemented.

In the case of asymmetric load distribution, it is not possible to ensure correct functionality.

<b>⚠ WARNING</b>
<b>SELV is not guaranteed in the case of a fault</b>
When connecting two power supplies in series, the continuous, permissible SELV voltage of a maximum of 60 VDC according to EN 60950 cannot be guaranteed in the case of a fault.

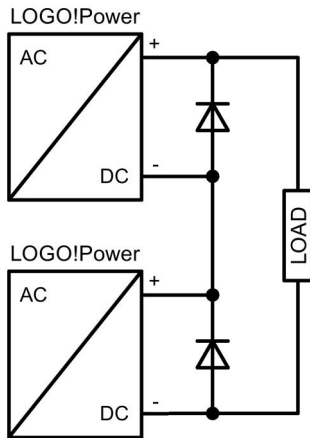

Figure 9-3 Series connection

## **9.4 Protection against short-time voltage dips**

During a drop in the primary-side supply voltage, the LOGO!Power power supplies still maintain the output voltage over a short millisecond period (see Section Technical data (Page 55) Power failure buffering).



## Environment

The devices are in conformance with RoHS.

As a rule, only non-silicon precipitating materials are used.

### Disposal guidelines



Packaging and packaging aids can and should always be recycled. The product itself may not be disposed of as domestic refuse.





## Service & Support

### Technical support

Technical support for all IA/DT products can be accessed through the following communication channels:

- Telephone: + 49 (0) 911 895 7222
- Internet:  
Online support request form (<http://www.siemens.de/automation/support-request>)

### Technical documentation on the Internet

Operating instructions and manuals for SITOP are available in the Internet:  
Operating instructions/manuals (<http://www.siemens.com/sitop/manuals>)

### SITOP power supply homepage

General news about our power supplies is available in the Internet at the SITOP home page:  
SITOP (<http://www.siemens.com/sitop>)

### Information material

SITOP information can be downloaded from the Internet:  
Information and download center (<http://www.siemens.com/sitop-infomaterial>)

### CAX data

2D/3D data and circuit diagram macros can be downloaded from the Internet:  
Siemens image database (<http://www.siemens.com/sitop-cax>)

Request all CAX data via the CAX download manager:  
CAX shopping cart (<http://www.siemens.com/cax>)

### SITOP Selection Tool

Simply and quickly select the optimum the power supply or DC-UPS:  
SITOP Selection Tool (<http://www.siemens.com/sitop-selection-tool>)

### Online catalog and ordering system

The online catalog and the online ordering system are available through the Industry Mall homepage:  
Industry Mall (<http://www.siemens.com/industrymall/de>)

### **Contact persons**

If you have any questions regarding the use of our products, then contact the Siemens contact person in your regional Siemens sales office.

You can find these addresses as follows:

- On the Internet (<http://www.automation.siemens.com/partner>)
- In Catalog CA 01