

Enclosure for command devices, 22 mm, round, Enclosure material metal, enclosure top part gray, 1 control point, without equipment, Recess for labels, floor mounting, 1xM20 each on top and bottom



Figure similar

Product brand name	SIRIUS ACT
Product designation	Enclosures
Product type designation	3SU1

Enclosure	
Design of the housing	with recess for label
Shape of the enclosure front	Square
Material of the enclosure	metal
Number of command points	1
Product component	
• protective collar	No
Color	
• of top part of the enclosure	grey
Mounting type of the enclosure	Vertical / horizontal

General technical data	
Protection class IP	IP66, IP67, IP69(IP69K)
Degree of protection NEMA rating	NEMA 1, 2, 3, 3R, 4, 4X, 12, 13
Shock resistance	

<ul style="list-style-type: none"> • for railway applications acc. to DIN EN 61373 	Category 1, Class B
Vibration resistance	
<ul style="list-style-type: none"> • for railway applications acc. to DIN EN 61373 	Category 1, Class B

Mechanical data

Cable entry type	Without
-------------------------	---------

Connections/Terminals

Type of electrical connection on enclosure	Cable routing above and below, both 1 x M20
Tightening torque of mounting screws in the enclosure cover	1.5 ... 1.7 N·m







Ambient conditions

Ambient temperature	
<ul style="list-style-type: none"> • during operation 	-25 ... +70 °C
<ul style="list-style-type: none"> • during storage 	-40 ... +80 °C

Installation/ mounting/ dimensions

Mounting type	
<ul style="list-style-type: none"> • of modules and accessories 	Floor mounting
Height	89.4 mm
Width	85 mm
Depth	64 mm
Mounting diameter	22.3 mm
Positive tolerance of installation diameter	0.4 mm

Certificates/approvals

General Product Approval	Declaration of Conformity
 CCC	 CSA
 UL	 VDE
 EAC	 EG-Konf.

Test Certificates	other
Declaration of the Compliance with the order	Special Test Certificate
	Confirmation

Further information

Information- and Downloadcenter (Catalogs, Brochures,...)
<http://www.siemens.com/industrial-controls/catalogs>

Industry Mall (Online ordering system)
<https://mall.industry.siemens.com/mall/en/en/Catalog/product?mlfb=3SU1851-0AA00-0AB1>

Cax online generator
<http://support.automation.siemens.com/WW/CAXorder/default.aspx?lang=en&mlfb=3SU1851-0AA00-0AB1>

Service&Support (Manuals, Certificates, Characteristics, FAQs,...)

<https://support.industry.siemens.com/cs/ww/en/ps/3SU1851-0AA00-0AB1>

Image database (product images, 2D dimension drawings, 3D models, device circuit diagrams, EPLAN macros, ...)

http://www.automation.siemens.com/bilddb/cax_de.aspx?mlfb=3SU1851-0AA00-0AB1&lang=en

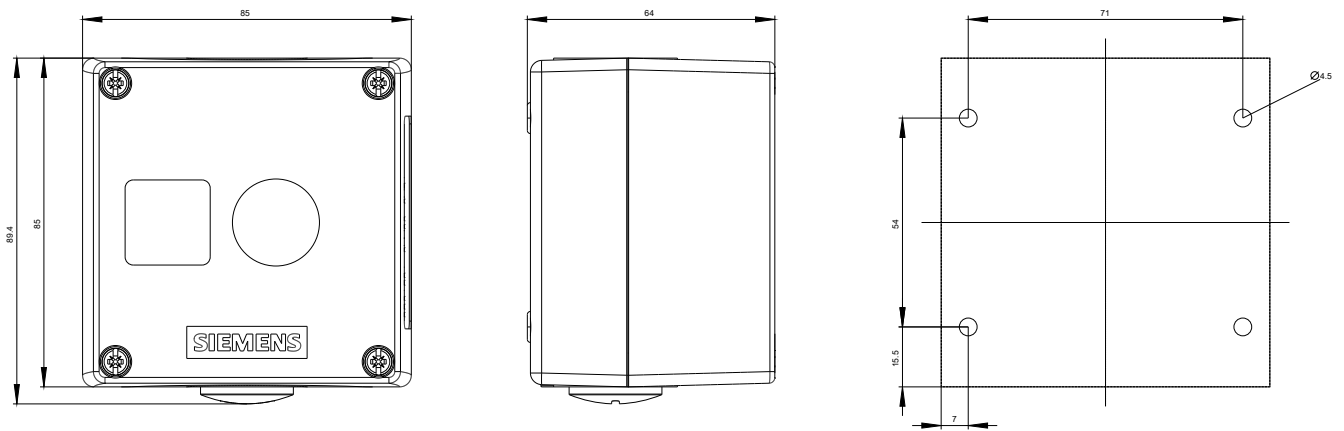

last modified:

01/30/2018