

FOOT -OPERATED BUTTON, (WITHOUT LATCHING) SINGLE PEDAL, M20X1,5 CABLE ENTRY IP65, 1NO + 1NC WITH COVER

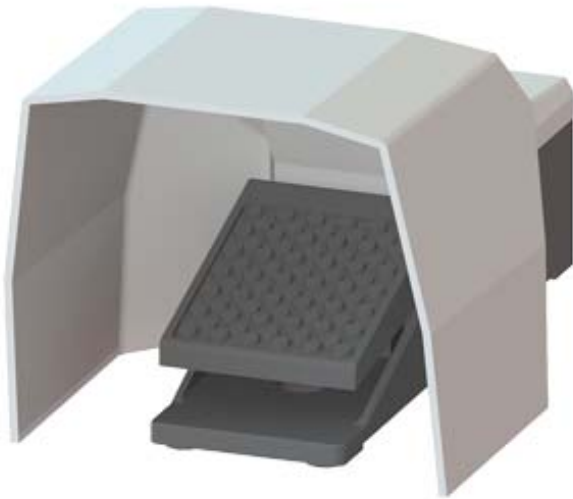

Product designation	momentary-contact foot switch
General technical data	
Protection class IP	IP65
Equipment marking	
• acc. to DIN EN 61346-2	S
• acc. to DIN EN 81346-2	S
Number of switching steps	1
Number of the actuation pedals	1
Operating current at AC-15	
• at 230 V rated value	16 A
• at 400 V rated value	16 A
Operating current at DC-13	
• at 24 V rated value	3 A
Enclosure	
Material of the enclosure	metal
Color	
• of the enclosure	black
• of top part of the enclosure	grey

Safety related data

B10 value	
<ul style="list-style-type: none"> with high demand rate acc. to SN 31920 	1 000 000
Proportion of dangerous failures	
<ul style="list-style-type: none"> with low demand rate acc. to SN 31920 	50 %
<ul style="list-style-type: none"> with high demand rate acc. to SN 31920 	50 %
Failure rate [FIT]	
<ul style="list-style-type: none"> with low demand rate acc. to SN 31920 	100 FIT
T1 value for proof test interval or service life acc. to IEC 61508	20 y

Mechanical data

Cable entry type	M20 x 1.5
-------------------------	-----------









Ambient conditions

Ambient temperature	
<ul style="list-style-type: none"> during operation 	-25 ... +80 °C

Installation/ mounting/ dimensions

Mounting type	screw fixing
Height	265 mm
Width	156 mm
Depth	138 mm

Certificates/approvals

General Product Approval		Declaration of Conformity		Shipping Approval	
					
CCC	CSA		EG-Konf.	ABS	LRS
Shipping Approval			other		
		Confirmation	Miscellaneous		
PRS	RINA				

Further information

Information- and Downloadcenter (Catalogs, Brochures,...)

<http://www.siemens.com/industrial-controls/catalogs>

Industry Mall (Online ordering system)

<https://mall.industry.siemens.com/mall/en/en/Catalog/product?mlfb=3SE2902-0AA20>

Cax online generator

<http://support.automation.siemens.com/WW/CAXorder/default.aspx?lang=en&mlfb=3SE2902-0AA20>

Service&Support (Manuals, Certificates, Characteristics, FAQs,...)

<https://support.industry.siemens.com/cs/ww/en/ps/3SE2902-0AA20>

Image database (product images, 2D dimension drawings, 3D models, device circuit diagrams, EPLAN macros, ...)

http://www.automation.siemens.com/bilddb/cax_de.aspx?mlfb=3SE2902-0AA20&lang=en

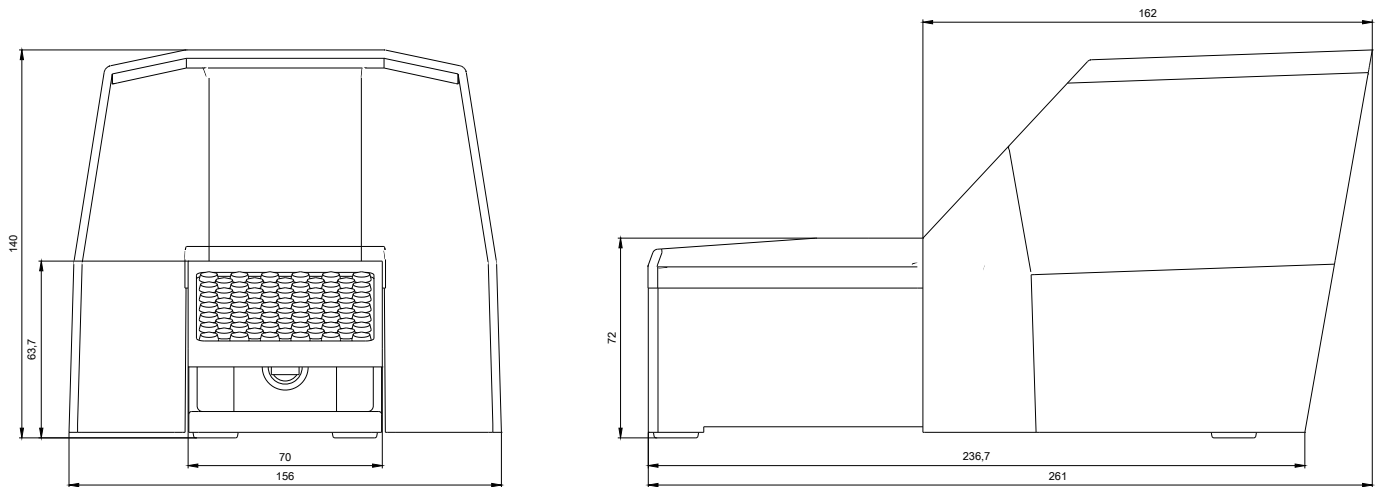

last modified:

09/25/2017